

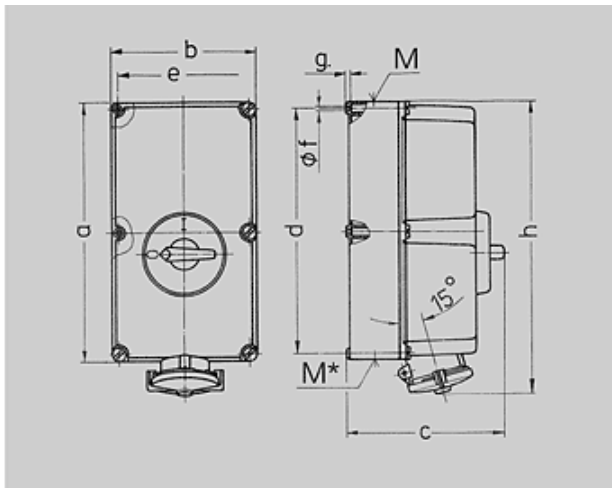

N° de Ref. : 5691A

Base

con interruptor y enclavamiento mecánico DUO



Plano	Amp.	125		
		3	4	5
1 MB 177	Polos			
Dim. en mm	a	460	460	460
	b	260	260	260
	c	283	283	283
	d	434	434	434
	e	234	234	234
	f	11	11	11
	g	9	9	9
	h	525	525	525
	M	63	63	63
	M*	2x63	2x63	2x63
	Diám. máx. de cable (mm)	44	44	44
	Borna para cond. Sección Transvers. (mm ²) min.-max.	25	25	25
		-70	-70	-70

 Grupo de artículos : **1074**

voltages : 400V

rated current : 125A

pole : 4 pole







SCHUKO IP protection types : IP67

position of ground contact : 6h

packing unit : 0001

Peso : 7450 g

N° DE REF.

V	110V	230V	400V	500V	>50-500V	
Hz	50,60	50,60	50,60	50,60	100-300	300-500
Color código						
Amperios						
125 A	3	7000				
	4	5887A	5691A	5690A		
	5	5888A	5692A			