

Inductive proximity sensors

Cylindrical type, Ø 4 mm plain or M5 x 0.5 threaded
Metal case (stainless steel), short
d.c. supply

Accessories :
page 3/59

References, characteristics, dimensions, schemes

Flush mountable in metal

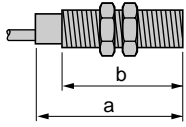

Lengths (mm) :
a = Overall
b = Threaded or plain section

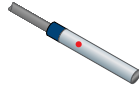

a = 29
b = 29

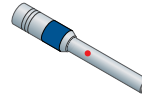

a = 41
b = 24

Nominal sensing distance (S _n)	0.8 mm	0.8 mm
--	--------	--------

References

3-wire ---	PNP	NO	XS1-L04PA311	XS1-L04PA311S
	NPN	NO	XS1-L04NA311	XS1-L04NA311S
Weight (kg)			0.025	0.010

Characteristics

Connection	Pre-cabled, 3 x 0.11 mm ² , length 2 m (1)	Connector (types 1 to 8) (2)
Degree of protection	IP 67	Depending on connector (see pages 3/58 and 3/59)
Operating temperature	- 25...+ 70 °C	
Output state indication	LED, side mounted	
Voltage limits (including ripple)	--- 5...30 V	
Switching capacity	0...100 mA with overload and short-circuit protection	
Voltage drop, closed state	≤ 2 V	
Current consumption, no-load	≤ 10 mA	
Maximum switching frequency	5000 Hz	

Wiring schemes

3-wire ---, NO output

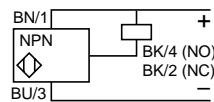
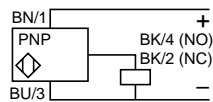

(1) Sensors pre-cabled with other cable lengths :

Length of cable	Suffix to be added to references stated above for 2 m pre-cabled sensors	Weight increase
5 m	L1	0.030 kg
10 m	L2	0.080 kg

Example : sensor **XS1-L04PA311** with 5 m cable becomes **XS1-L04PA311L1**

(2) The type numbers refer to suitable female connectors and extension cables, see pages 3/58 and 3/59.

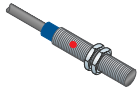

a = 29
b = 24

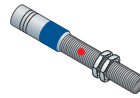

a = 41
b = 24

0.8 mm	0.8 mm
--------	--------

XS1-N05PA311	XS1-N05PA311S
XS1-N05NA311	XS1-N05NA311S
0.030	0.015

Pre-cabled, 3 x 0.11 mm², length 2 m (1)	Connector (types 1 to 8) (2)
IP 67	Depending on connector (see pages 3/58 and 3/59)
- 25...+ 70 °C	
LED, side mounted	
~ 5...30 V	
0...100 mA with overload and short-circuit protection	
≤ 2 V	
≤ 10 mA	
5000 Hz	

Inductive proximity sensors

Cylindrical type, Ø 6.5 mm plain
Metal case (brass or stainless steel), short
d.c. supply

Accessories :
page 3/59

References, characteristics, dimensions, schemes

Flush mountable in metal

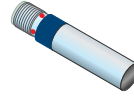
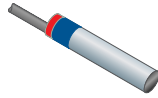
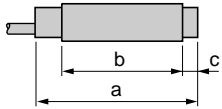

Lengths (mm) :
a = Overall
b = Plain section
c = For non flush mounting sensors

a = 33 (XS1-L06●C410 : a = 50)
b = 30 (XS1-L06●C410 : b = 47)

a = 42
b = 34

	Stainless steel case	Brass case	Stainless steel case	Brass case
Nominal sensing distance (S_n)	1.5 mm	Increased range model 2.5 mm	1.5 mm	Increased range model 2.5 mm

References

3-wire ---	PNP	NO	XS1-L06PA340	XS1-L06PA349	XS1-L06PA340S	XS1-L06PA349S
	NPN	NO	XS1-L06NA340	XS1-L06NA349	XS1-L06NA340S	XS1-L06NA349S
4-wire --- (complementary outputs)	PNP	NO + NC	XS1-L06PC410	–	–	–
	NPN	NO + NC	XS1-L06NC410	–	–	–
Weight (kg)			0.025	0.025	0.010	0.010

Characteristics

Connection	Pre-cabled, 3 x 0.11 mm² or 4 x 0.08 mm², L = 2 m (1)		Connector (types 1 to 8) (2)	
Degree of protection	IP 67		Depending on connector (see pages 3/58 and 3/59)	
Operating temperature	- 25...+ 70 °C	- 25...+ 50 °C	- 25...+ 70 °C	- 25...+ 50 °C
Output state indication	LED, annular		LED, 4 viewing ports at 90°	
Voltage limits (including ripple)	--- 10...38 V (~ 24 V rectified and filtered)			
Switching capacity	0...200 mA with overload and short-circuit protection			
Voltage drop, closed state	≤ 2 V	≤ 2.6 V	≤ 2 V	≤ 2.6 V
Current consumption, no-load	≤ 10 mA	≤ 10 mA	≤ 10 mA	≤ 10 mA
Maximum switching frequency	5000 Hz	350 Hz	5000 Hz	350 Hz

Wiring schemes

3-wire ---, NO output

XS1/XS2-L06●●340/340S/340D/349/349S/349D



4-wire ---, NO + NC output

XS1-L06●●410

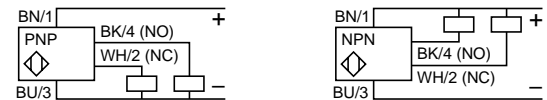

Note : for **XS●-L06●●34●S** sensors, NO or NC output on terminal 4

(1) Sensors pre-cabled with other cable lengths :

Length of cable	Suffix to be added to references stated above for 2 m pre-cabled sensors	Weight increase
5 m	L1	0.030 kg
10 m	L2	0.080 kg

Example : sensor **XS1-L06PA340** with 5 m cable becomes **XS1-L06PA340L1**

(2) The type numbers refer to suitable female connectors and extension cables, see pages 3/58 and 3/59.

Non flush mountable in metal

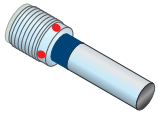

a = 45
b = 24

Stainless steel case

1.5 mm

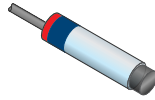

a = 33
b = 27
c = 3

Stainless steel case

2.5 mm

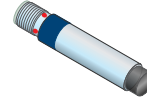

a = 42
b = 31
c = 3

Stainless steel case

2.5 mm

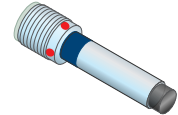

a = 45
b = 21
c = 3

Stainless steel case

2.5 mm

XS1-L06PA340D	XS1-L06PA349D	XS2-L06PA340	XS2-L06PA340S	XS2-L06PA340D
XS1-L06NA340D	XS1-L06NA349D	XS2-L06NA340	XS2-L06NA340S	XS2-L06NA340D
-	-	-	-	-
-	-	-	-	-
0.015	0.015	0.025	0.010	0.015

Connector (types 9, 10, 11/12, 15, 16) (2)	Connector (types 9, 10, 11, 12, 15, 16) (2)	Pre-cabled, 3 x 0.11 or 4 x 0.08 mm ² , L = 2 m (1)	Connector (types 1 to 8) (2)	Connector (types 9, 10, 11/12, 15, 16) (2)
Depending on connector (see pages 3/58 and 3/59)		IP 67	Depending on connector (see pages 3/58 and 3/59)	
- 25...+ 70 °C	- 25...+ 50 °C	- 25...+ 70 °C		
LED, 4 viewing ports at 90°		LED, annular	LED, 4 viewing ports at 90°	
⎓ 10...38 V (~ 24 V rectified and filtered)				
0...200 mA with overload and short-circuit protection				
≤ 2 V	≤ 2.6 V	≤ 2 V		
≤ 10 mA	≤ 10 mA	≤ 10 mA		
5000 Hz	350 Hz	5000 Hz		

Inductive proximity sensors

Cylindrical type, M8 x 1 threaded
Metal case (brass), short
d.c. supply

Accessories :
page 3/59

References, characteristics, dimensions, schemes

Flush mountable in metal

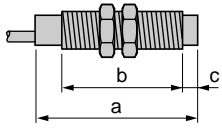

Lengths (mm) :
a = Overall
b = Threaded section
c = For non flush mounting sensors

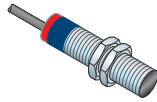

a = 33
b = 26

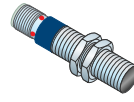

a = 42
b = 26

Nominal sensing distance (S _n)	1.5 mm	Increased range model 2.5 mm	1.5 mm	Increased range model 2.5 mm
--	--------	---------------------------------	--------	---------------------------------

References

3-wire ---	PNP	NO	XS1-N08PA340	XS1-N08PA349	XS1-N08PA340S	XS1-N08PA349S
	NPN	NO	XS1-N08NA340	XS1-N08NA349	XS1-N08NA340S	XS1-N08NA349S
Weight (kg)			0.035	0.035	0.015	0.015

Characteristics

Connection	Pre-cabled, 3 x 0.11 mm ² or 4 x 0.08 mm ² , L = 2 m (1)		Connector (types 1 to 8) (2)	
Degree of protection	IP 67		Depending on connector (see pages 3/58 and 3/59)	
Operating temperature	- 25...+ 70 °C	- 25...+ 50 °C	- 25...+ 70 °C	- 25...+ 50 °C
Output state indication	LED, annular		LED, 4 viewing ports at 90°	
Voltage limits (including ripple)	--- 10...38 V (~ 24 V rectified and filtered)			
Switching capacity	0...200 mA with overload and short-circuit protection			
Voltage drop, closed state	≤ 2 V	≤ 2.6 V	≤ 2 V	≤ 2.6 V
Current consumption, no-load	≤ 10 mA	≤ 10 mA	≤ 10 mA	≤ 10 mA
Maximum switching frequency	5000 Hz	350 Hz	5000 Hz	350 Hz

Wiring schemes

3-wire ---, NO output
XS1/XS2-N08●●340/340S/340D/349/349S/349D



Note : for **XS●-N08●●34●S** sensors, NO output on terminal 4

(1) Sensors pre-cabled with other cable lengths :

Length of cable	Suffix to be added to references stated above for 2 m pre-cabled sensors	Weight increase
5 m	L1	0.030 kg
10 m	L2	0.080 kg

Example : sensor **XS1-N08PA340** with 5 m cable becomes **XS1-N08PA340L1**

(2) The type numbers refer to suitable female connectors and extension cables, see pages 3/58 and 3/59.

Non flush mountable in metal

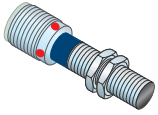

a = 45
b = 24

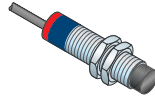

a = 33
b = 22
c = 4

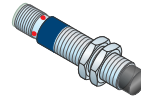

a = 42
b = 23
c = 4

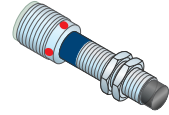

a = 45
b = 20
c = 4

1.5 mm	Increased range model 2.5 mm	2.5 mm	2.5 mm	2.5 mm
--------	---------------------------------	--------	--------	--------

XS1-N08PA340D	XS1-N08PA349D	XS2-N08PA340	XS2-N08PA340S	XS2-N08PA340D
XS1-N08NA340D	XS1-N08NA349D	XS2-N08NA340	XS2-N08NA340S	XS2-N08NA340D
0.020	0.020	0.035	0.015	0.020

Connector (types 9, 10, 11/12, 15, 16) (2)	Connector (types 9, 10, 11/12, 15, 16) (2)	Pre-cabled, 3 x 0.11 or 4 x 0.08 mm ² , L = 2 m (1)	Connector (types 1 to 8) (2)	Connector (types 9, 10, 11/12, 15, 16) (2)
Depending on connector (see pages 3/58 and 3/59)		IP 67	Depending on connector (see pages 3/58 and 3/59)	
- 25...+ 70 °C	- 25...+ 50 °C	- 25...+ 70 °C		
LED, 4 viewing ports at 90°		LED, annular	LED, 4 viewing ports at 90°	
≡ 10...38 V (~ 24 V rectified and filtered)				
0...200 mA with overload and short-circuit protection				
≤ 2 V	≤ 2.6 V	≤ 2 V		
≤ 10 mA	≤ 10 mA	≤ 10 mA		
5000 Hz	350 Hz	800 Hz		

Inductive proximity sensors

Cylindrical type, M8 x 1 threaded
Metal case (stainless steel), form A
d.c. supply

Accessories:
page 3/59

References, characteristics, dimensions, schemes

Flush mountable in metal

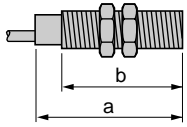

Lengths (mm) :
a = Overall
b = Threaded section

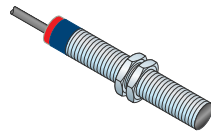

a = 50
b = 40

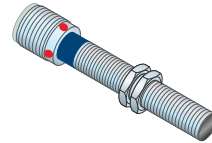

a = 61
b = 40

Nominal sensing distance (S _n)	1.5 mm	1.5 mm
--	--------	--------

References

3-wire ---	PNP	NO	XS1-M08PA370	–	XS1-M08PA370D	–
		NC	XS1-M08PB370	–	XS1-M08PB370D	–
	NPN	NO	XS1-M08NA370	–	XS1-M08NA370D	–
2-wire --- (non polarised)	Supply to : Terminals 3-4 NO		–	–	–	–
4-wire --- (complementary outputs)	PNP	NO + NC	–	XS1-M08PC410	–	XS1-M08PC410D
Weight (kg)			0.035	0.035	0.025	0.025

Characteristics

Connection	Pre-cabled, 3 x 0.11 mm ² , length 2 m (1)	Connector (types 9, 10, 11/12, 15, 16) (2)
Degree of protection	IP 67	Depending on connector (see pages 3/58 and 3/59)
Operating temperature	- 25...+ 80 °C	
Output state indication	LED annular	LED, 4 viewing ports at 90°
Voltage limits (including ripple)	--- 10...58 V	--- 10...38 V
Switching capacity	0...200 mA with overload and short-circuit protection	
Voltage drop, closed state	≤ 2 V	
Current consumption, no-load	≤ 10 mA	
Maximum switching frequency	5000 Hz	

Wiring schemes

3-wire ---, NO or NC output
XS1-M08●●370/370D

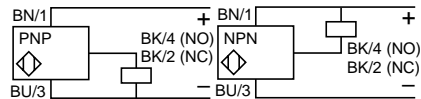

2-wire --- non polarised, NO output
XS1-M08D●210/210D/210LD

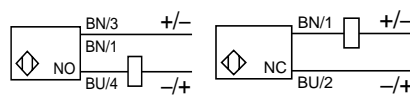

4-wire ---, NO + NC output
XS1-M08●●410/410D

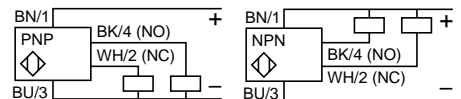

(1) Sensors pre-cabled with other cable lengths:

Length of cable	Suffix to be added to references stated above for 2 m pre-cabled sensors	Weight increase
5 m	L1	0.030 kg
10 m	L2	0.080 kg

Example: sensor XS1-M08PA370 with 5 m cable becomes XS1-M08PA370L1

(2) The type numbers refer to suitable female connectors and extension cables, see pages 3/58 and 3/59.

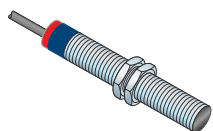

a = 50
b = 40

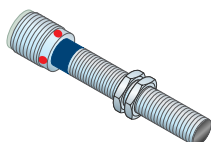

a = 61
b = 40

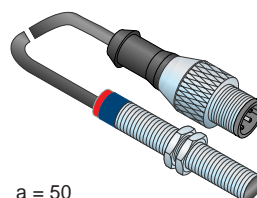

a = 50
b = 40
Length of cable: 0.8 m

1.5 mm	1.5 mm	1.5 mm
--------	--------	--------

-	-	-
-	-	-
-	-	-
XS1-M08DA210	XS1-M08DA210D	XS1-M08DA210LD
-	-	-
0.035	0.025	0.040

3

Pre-cabled, 2 x 0.11 mm², length 2 m (1)	Connector (types 9, 10, 15, 16) (2)	Connector (types 9, 10, 15, 16) or splitter boxes (2)
IP 67	Dpg. on connector (see pages 3/58 and 3/59)	
- 25...+ 80 °C		
LED, annular	LED, 4 viewing ports at 90°	LED, annular
~ 10...58 V		
1,5...100 mA with overload and short-circuit protection		
≤ 5.2 V		
-		
800 Hz		

Inductive proximity sensors

Cylindrical type, M8 x 1 threaded
Metal case (stainless steel), form A
a.c. or d.c. supply

Accessories :
page 3/59

References, characteristics, dimensions, schemes

Flush mountable in metal

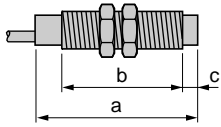

Lengths (mm) :
a = Overall
b = Threaded section
c = For non flush mounting sensors

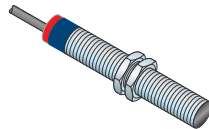

a = 50
b = 40

Nominal sensing distance (S_n)	1.5 mm
---	---------------

References

2-wire ~ or ---	NO	XS1-M08MA230
	NC	XS1-M08MB230
Weight (kg)	0.035	

Characteristics

Connection	Pre-cabled, 2 x 0.11 mm², length 2 m (1)
Degree of protection	IP 67
Operating temperature	- 25...+ 80 °C
Output state indication	LED, annular
Voltage limits (including ripple)	~ or --- 20...264 V
Switching capacity	5...100 mA (2)
Voltage drop, closed state	≤ 5.5 V
Current consumption, no-load	–
Maximum switching frequency	(~) 25 Hz or (---) 650 Hz

Wiring schemes

2-wire ~ or ---, NO or NC output

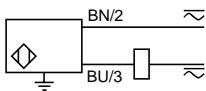

⏏ For connector version sensors

(1) Sensors pre-cabled with other cable lengths :

Length of cable	Suffix to be added to references stated above for 2 m pre-cabled sensors	Weight increase
5 m	L1	0.030 kg
10 m	L2	0.080 kg

Example : sensor **XS1-M08MA230** with 5 m cable becomes **XS1-M08MA230L1**

(2) These sensors do not incorporate overload or short-circuit protection and therefore, it is recommended that a 0.8 A "quick-blow" fuse be connected in series with the load.

Non flush mountable in metal

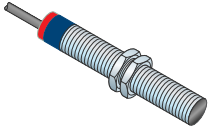

a = 50
b = 36
c = 4

2.5 mm

XS2-M08MA230

XS2-M08MB230

0.035

Pre-cabled, 2 x 0.11 mm², length 2 m (1)

IP 67

- 25...+ 80 °C

LED, annular

~ or = 20...264 V

5...100 mA (2)

≤ 5.5 V

-

(~) 25 Hz or (=) 400 Hz

3

Inductive proximity sensors

Cylindrical type, M12 x 1 threaded
Metal case (brass), short
d.c. supply

Accessories :
page 3/59

References, characteristics, dimensions, schemes

Flush mountable in metal

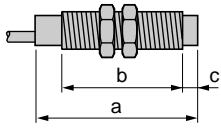

Lengths (mm) :
a = Overall
b = Threaded section
c = For non flush mounting sensors

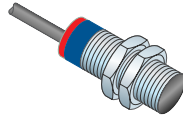

a = 33
b = 26

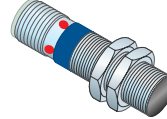

a = 45
b = 25

Nominal sensing distance (S _n)	2 mm	Increased range model 4 mm	2 mm	Increased range model 4 mm
--	------	-------------------------------	------	-------------------------------

References

3-wire $\overline{\text{---}}$	PNP	NO	XS1-N12PA340	XS1-N12PA349	XS1-N12PA340D	XS1-N12PA349D
	NPN	NO	XS1-N12NA340	XS1-N12NA349	XS1-N12NA340D	XS1-N12NA349D
4-wire $\overline{\text{---}}$ (complementary outputs)	PNP	NO + NC	XS1-N12PC410	–	XS1-N12PC410D	–
Weight (kg)			0.070	0.070	0.020	0.020

Characteristics

Connection	Pre-cabled, 3 x 0.34 mm ² or 4 x 0.22 mm ² , length 2 m (1)		Connector (types 9, 10, 15, 16) (2)	Connector (types 9, 10, 11, 12, 15, 16) (2)
Degree of protection	IP 67		Depending on connector (see pages 3/58 and 3/59)	
Operating temperature	- 25...+ 70 °C	- 25...+ 50 °C	- 25...+ 70 °C	- 25...+ 50 °C
Output state indication	LED, annular		LED, 4 viewing ports at 90°	
Voltage limits (including ripple)	$\overline{\text{---}}$ 10...38 V (\sim 24 V rectified and filtered)			
Switching capacity	0...200 mA with overload and short-circuit protection			
Voltage drop, closed state	\leq 2 V	\leq 2.6 V	\leq 2 V	\leq 2.6 V
Current consumption, no-load	\leq 10 mA			
Maximum switching frequency	5000 Hz	300 Hz	5000 Hz	300 Hz

Wiring schemes

3-wire $\overline{\text{---}}$, NO output
XS1/XS2-N12●●340/340D/349/349D



4-wire $\overline{\text{---}}$, NO + NC output
XS1-N12●●410/410D



(1) Sensors pre-cabled with other cable lengths :

Length of cable	Suffix to be added to references stated above for 2 m pre-cabled sensors	Weight increase
5 m	L1	0.090 kg
10 m	L2	0.240 kg

Example : sensor **XS1-N12PA340** with 5 m cable becomes **XS1-N12PA340L1**

(2) The type numbers refer to suitable female connectors and extension cables, see pages 3/58 and 3/59.

Non flush mountable in metal

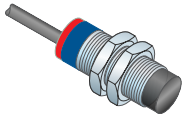

a = 33
b = 21
c = 5

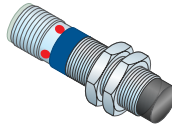

a = 45
b = 20
c = 5

4 mm

4 mm

XS2-N12PA340	XS2-N12PA340D
XS2-N12NA340	XS2-N12NA340D
-	-
0.070	0.020

Pre-cabled, 3 x 0.34 mm ² or 4 x 0.22 mm ² , length 2 m (1)	Connector (types 9, 10, 15, 16) (2)
IP 67	Depending on connector (see pages 3/58 and 3/59)
- 25...+ 70 °C	
LED, annular	LED, 4 viewing ports at 90°
≡ 10...38 V (≈ 24 V rectified and filtered)	
0...200 mA with overload and short-circuit protection	
≤ 2 V	
≤ 10 mA	
5000 Hz	

3

Inductive proximity sensors

Cylindrical type, M12 x 1 threaded
Metal case (brass), form A
d.c. supply

Accessories :
page 3/59

References, characteristics, dimensions, schemes

Flush mountable in metal

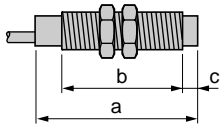

Lengths (mm) :
a = Overall
b = Threaded section
c = For non flush mounting sensors

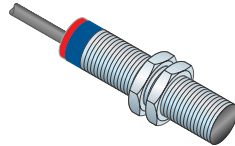

a = 50
b = 42

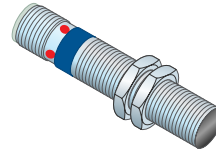

a = 61
b = 40

Nominal sensing distance (S _n)	2 mm	2 mm	2 mm	2 mm
--	------	------	------	------

References

3-wire ---	PNP	NO	XS1-M12PA370	–	XS1-M12PA370D	–
	NPN	NO	XS1-M12NA370	–	XS1-M12NA370D	–
4-wire --- universal model	PNP/NPN programmable	NO/NC	–	XS1-M12KP340	–	XS1-M12KP340D
Weight (kg)			0.075	0.075	0.025	0.025

Characteristics

Connection	Pre-cabled, 3 x 0.34 mm ² , length 2 m (1)			
Degree of protection	IP 68		Depending on connector (see pages 3/58 and 3/59)	
Operating temperature	- 25...+ 80 °C			
Output state indication	LED, annular		LED, 4 viewing ports at 90°	
Voltage limits (including ripple)	--- 10...58 V (3)	--- 10...38 V (4)	--- 10...58 V (3)	--- 10...38 V (4)
Switching capacity	0...200 mA with overload and short-circuit protection			
Voltage drop, closed state	≤ 2 V	≤ 2.6 V	≤ 2 V	≤ 2.6 V
Current consumption, no-load	≤ 10 mA			
Maximum switching frequency	5000 Hz			

Wiring schemes

3-wire ---, NO output
XS1/XS2-M12●●370/370D



4-wire --- programmable, NO or NC output
XS1/XS2-M12KP340/340D



(1) Sensors pre-cabled with other cable lengths :

Length of cable	Suffix to be added to references stated above for 2 m pre-cabled sensors	Weight increase
5 m	L1	0.090 kg
10 m	L2	0.240 kg

Example : sensor **XS1-M12PA370** with 5 m cable becomes **XS1-M12PA370L1**

(2) The type numbers refer to suitable female connectors and extension cables, see pages 3/58 and 3/59.

(3) Can be supplied with rectified ~ 24 V.

(4) ~ 24 V rectified and filtered.

Non flush mountable in metal

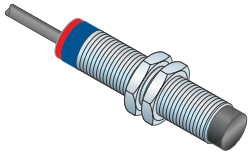

a = 50
b = 37
c = 5

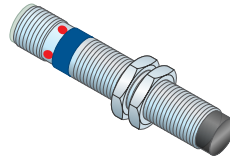

a = 61
b = 35
c = 5

4 mm	4 mm	4 mm	4 mm
------	------	------	------

XS2-M12PA370	–	XS2-M12PA370D	–
XS2-M12NA370	–	XS2-M12NA370D	–
–	XS2-M12KP340	–	XS2-M12KP340D
0.075	0.075	0.025	0.075

Pre-cabled, 3 x 0.34 mm², length 2 m (1)		Connector (types 9, 10, 15, 16) (2)	
IP 68		Depending on connector (see pages 3/58 and 3/59)	
- 25...+ 80 °C			
LED, annular		LED, 4 viewing ports at 90°	
≡ 10...58 V (3)	≡ 10...38 V (4)	≡ 10...58 V (3)	≡ 10...38 V (4)
0...200 mA with overload and short-circuit protection			
≤ 2 V	≤ 2.6 V	≤ 2 V	≤ 2.6 V
≤ 10 mA			
5000 Hz			

3

Inductive proximity sensors

Cylindrical type, M12 x 1 threaded
Metal case (brass), form A
d.c. supply (continued)

Accessories :
page 3/59

References, characteristics, dimensions, schemes

Flush mountable in metal

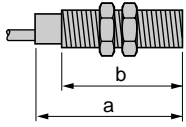

Lengths (mm) :
a = Overall
b = Threaded section

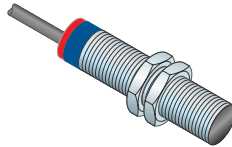

a = 50
b = 42

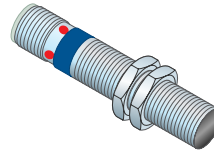

a = 61
b = 40

Nominal sensing distance (S _n)	2 mm	2 mm
--	------	------

References

2-wire \equiv (non polarised) Supply to : Terminals 3-4 NO	XS1-M12DA210	XS1-M12DA210D
Terminals 1-2 NC	XS1-M12DB210	XS1-M12DB210D
Weight (kg)	0.075	0.025

Characteristics

Connection	Pre-cabled, 2 x 0.34 mm ² , length 2 m (1)	Connector (types 9, 10, 15, 16) (2)
Degree of protection	IP 68	Depending on connector (see pages 3/58 and 3/59)
Operating temperature	- 25...+ 80 °C	
Output state indication	LED, annular	LED, 4 viewing ports at 90°
Voltage limits (including ripple)	\equiv 10...58 V	
Switching capacity	1.5...100 mA with overload and short-circuit protection	
Voltage drop, closed state	≤ 5.2 V	
Current consumption, no-load	-	
Maximum switching frequency	800 Hz	

Wiring schemes

2-wire \equiv non polarised, NO or NC output
XS1-M12DA210/DA210D

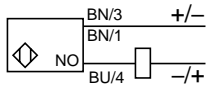

XS1-M12DB210/210D/210LD

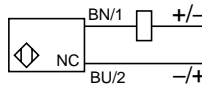

(1) Sensors pre-cabled with other cable lengths :

Length of cable	Suffix to be added to references stated above for 2 m pre-cabled sensors	Weight increase
5 m	L1	0.090 kg
10 m	L2	0.240 kg

Example : sensor **XS1-M12DA210** with 5 m cable becomes **XS1-M12DA210L1**

(2) The type numbers refer to suitable female connectors and extension cables, see pages 3/58 and 3/59.

Inductive proximity sensors

Cylindrical type, M12 x 1 threaded
Metal case (brass), form A
a.c. or d.c. supply

Accessories :
page 3/59

References, characteristics, dimensions, schemes

Flush mountable in metal

Non flush mountable in metal

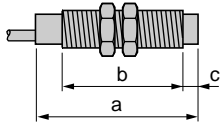

Lengths (mm) :
a = Overall
b = Threaded section
c = For non flush mounting sensors

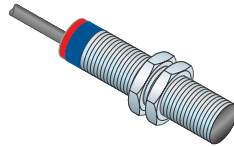

a = 50
b = 42

AC/DC

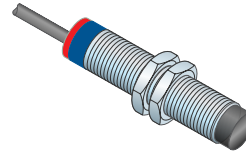

a = 50
b = 37
c = 5

AC/DC

Nominal sensing distance (S_n)

2 mm

4 mm

References

2-wire ~ or ---	NO	XS1-M12MA230	XS2-M12MA230
	NC	XS1-M12MB230	XS2-M12MB230
2-wire ~ or --- (protected against short-circuits)	NO	XS1-M12MA250	XS2-M12MA250
	NC	XS1-M12MB250	XS2-M12MB250
Weight (kg)		0.075	0.075

Characteristics

Connection	Pre-cabled, 2 x 0.34 mm ² , L = 2 m (1)
Degree of protection	IP 68
Operating temperature	- 25...+ 80 °C
Output state indication	LED, annular
Voltage limits (including ripple)	~ or --- 20...264 V
Switching capacity	5...200 mA (3)
Voltage drop, closed state	≤ 5.5 V
Current consumption, no-load	–
Maximum switching frequency	(~) 25 Hz or (---) 350 Hz

Wiring schemes

2-wire ~ or ---, NO or NC output
XS1/XS2-M12●●230/250

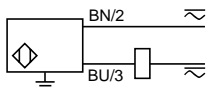

⊥ For connector version sensors

(1) Sensors pre-cabled with other cable lengths :

Length of cable	Suffix to be added to references stated above for 2 m pre-cabled sensors	Weight increase
5 m	L1	0.075 kg
10 m	L2	0.200 kg

Example : sensor **XS1-M12MA230** with 5 m cable becomes **XS1-M12MA230L1**

(2) The type numbers refer to suitable female connectors and extension cables, see pages 3/58 and 3/59.

(3) For the sensors not incorporating overload or short-circuit protection, it is recommended that a 0.8 A "quick-blow" fuse be connected in series with the load.

Inductive proximity sensors

Cylindrical type, M18 x 1 threaded
Metal case (brass), short
d.c. supply

Accessories :
page 3/59

References, characteristics, dimensions, schemes

Flush mountable in metal

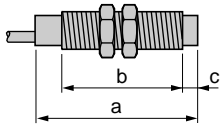

Lengths (mm) :
a = Overall
b = Threaded section
c = For non flush mounting sensors

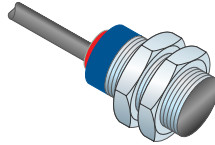

a = 33.5
b = 26

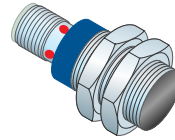

a = 45
b = 26

Nominal sensing distance (S _n)	5 mm	Increased range model 10 mm	5 mm	Increased range model 10 mm
--	------	--------------------------------	------	--------------------------------

References

3-wire ---	PNP	NO	XS1-N18PA340	XS1-N18PA349	XS1-N18PA340D	XS1-N18PA349D
	NPN	NO	XS1-N18NA340	XS1-N18NA349	XS1-N18NA340D	XS1-N18NA349D
4-wire --- (complementary outputs)	PNP	NO + NC	XS1-N18PC410	–	XS1-N18PC410D	–
	NPN	NO + NC	XS1-N18NC410	–	XS1-N18NC410D	–
Weight (kg)			0.100	0.100	0.040	0.040

Characteristics

Connection	Pre-cabled, 3 x 0.34 mm ² or 4 x 0.34 mm ² , length 2 m (1)		Connector (types 9, 10, 15, 16) (2)	Connector (types 9, 10, 11, 12, 15, 16) (2)
Degree of protection	IP 67		Depending on connector (see pages 3/58 and 3/59)	
Operating temperature	- 25...+ 70 °C	- 25...+ 50 °C	- 25...+ 70 °C	- 25...+ 50 °C
Output state indication	LED, annular		LED, 4 viewing ports at 90°	
Voltage limits (including ripple)	--- 10...38 V (~ 24 V rectified and filtered)			
Switching capacity	0...200 mA with overload and short-circuit protection			
Voltage drop, closed state	≤ 2 V	≤ 2.6 V	≤ 2 V	≤ 2.6 V
Current consumption, no-load	≤ 10 mA			
Maximum switching frequency	2000 Hz	60 Hz	2000 Hz	60 Hz

Wiring schemes

3-wire ---, NO output
XS1/XS2-N18●●340/340D/349/349D



4-wire ---, NO + NC output
XS1/XS2-N18●●410/410D



(1) Sensors pre-cabled with other cable lengths :

Length of cable	Suffix to be added to references stated above for 2 m pre-cabled sensors	Weight increase
5 m	L1	0.120 kg
10 m	L2	0.320 kg

Example : sensor **XS1-N18PA340** with 5 m cable becomes **XS1-N18PA340L1**

(2) The type numbers refer to suitable female connectors and extension cables, see pages 3/58 and 3/59.

Non flush mountable in metal

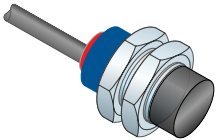

a = 33.5
b = 18
c = 8

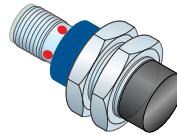

a = 45
b = 18
c = 8

8 mm	8 mm
------	------

XS2-N18PA340	XS2-N18PA340D
XS2-N18NA340	XS2-N18NA340D
-	-
-	-
0.100	0.030

Pre-cabled, 3 x 0.34 mm² or 4 x 0.34 mm², length 2 m (1)	Connector (types 9, 10, 15, 16) (2)
IP 67	Depending on connector (see pages 3/58 and 3/59)
- 25...+ 70 °C	
LED, annular	LED, 4 viewing ports at 90°
⎓ 10...38 V (~ 24 V rectified and filtered)	
0...200 mA with overload and short-circuit protection	
≤ 2 V	
≤ 10 mA	
2000 Hz	

3

Inductive proximity sensors

Cylindrical type, M18 x 1 threaded
Metal case (brass), form A
d.c. supply

Accessories :
page 3/59

References, characteristics, dimensions, schemes

Flush mountable in metal

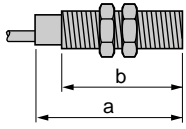

Lengths (mm) :
a = Overall
b = Threaded section

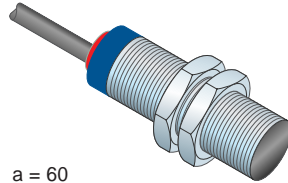

a = 60
b = 51.5

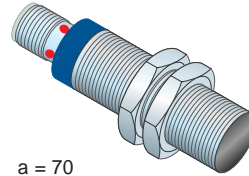

a = 70
b = 51.5

Nominal sensing distance (Sn)	5 mm	5 mm	5 mm	5 mm
-------------------------------	------	------	------	------

References

3-wire ---	PNP	NO	XS1-M18PA370	–	XS1-M18PA370D	–
	NPN	NO	XS1-M18NA370	–	XS1-M18NA370D	–
4-wire --- universal model	PNP/NPN programmable	NO/NC	–	XS1-M18KP340	–	XS1-M18KP340D
Weight (kg)			0.120	0.120	0.060	0.060

Characteristics

Connection	Pre-cabled, 3 x 0.34 mm ² , length 2 m (1)		Connector (types 9, 10, 15, 16) (2)	
Degree of protection	IP 68		Depending on connector (see pages 3/58 and 3/59)	
Operating temperature	- 25...+ 80 °C			
Output state indication	LED, annular		LED, 4 viewing ports at 90°	
Voltage limits (including ripple)	--- 10...58 V (3)	--- 10...38 V (4)	--- 10...58 V (3)	--- 10...38 V (4)
Switching capacity	0...200 mA with overload and short-circuit protection			
Voltage drop, closed state	≤ 2 V	≤ 2.6 V	≤ 2 V	≤ 2.6 V
Current consumption, no-load	≤ 10 mA			
Maximum switching frequency	2000 Hz			

Wiring schemes

3-wire ---, NO output
XS1-M18●●370/370D

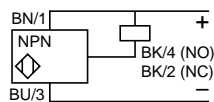
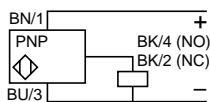

4-wire --- programmable, NO or NC output
XS1-M18KP340/340D

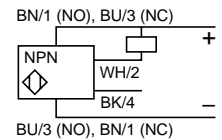
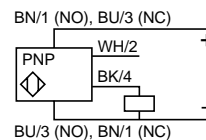

(1) Sensors pre-cabled with other cable lengths :

Length of cable	Suffix to be added to references stated above for 2 m pre-cabled sensors	Weight increase
5 m	L1	0.120 kg
10 m	L2	0.320 kg

Example : sensor **XS1-M18PA370** with 5 m cable becomes **XS1-M18PA370L1**

(2) The type numbers refer to suitable female connectors and extension cables, see pages 3/58 and 3/59.

(3) Can be supplied with rectified ~ 24 V.

(4) ~ 24 V rectified and filtered.

Inductive proximity sensors

Cylindrical type, M18 x 1 threaded
Metal case (brass), form A
d.c. supply (continued)

Accessories :
page 3/59

References, characteristics, dimensions, schemes

Non flush mountable in metal

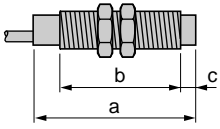

Lengths (mm) :
a = Overall
b = Threaded section
c = For non flush mounting sensors

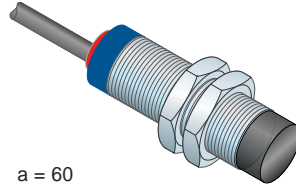

a = 60
b = 43.5
c = 8

Nominal sensing distance (S _n)	8 mm	8 mm
--	------	------

References

3-wire ---	PNP NO	XS2-M18PA370	-
	NPN NO	XS2-M18NA370	-
4-wire --- universal model	PNP/NPN NO/NC programmable	-	XS2-M18KP340
Weight (kg)		0.120	0.120

Characteristics

Connection	Pre-cabled, 3 x 0.34 mm ² , length 2 m (1)	
Degree of protection	IP 68	
Operating temperature	- 25...+ 80 °C	
Output state indication	LED, annular	
Voltage limits (including ripple)	--- 10...58 V (2)	--- 10...38 V (3)
Switching capacity	0...200 mA with overload and short-circuit protection	
Voltage drop, closed state	≤ 2 V	≤ 2.6 V
Current consumption, no-load	≤ 10 mA	
Maximum switching frequency	2000 Hz	

Wiring schemes

3-wire ---, NO output
XS2-M18●●370

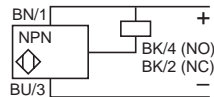
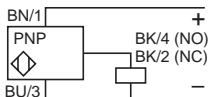

4-wire --- programmable, NO or NC output
XS2-M18KP340

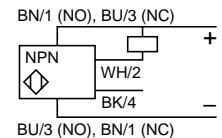
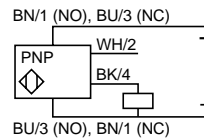

(1) Sensors pre-cabled with other cable lengths :

Length of cable	Suffix to be added to references stated above for 2 m pre-cabled sensors	Weight increase
5 m	L1	0.120 kg
10 m	L2	0.320 kg

Example : sensor **XS2-M18PA370** with 5 m cable becomes **XS2-M18PA370L1**

(2) Can be supplied with rectified ~ 24 V.

(3) ~ 24 V rectified and filtered.

Inductive proximity sensors

Cylindrical type, M18 x 1 threaded
Metal case (brass), form A
d.c. supply (continued)

Accessories :
page 3/59

References, characteristics, dimensions, schemes

Flush mountable in metal

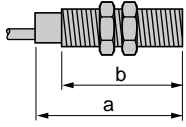

Lengths (mm) :
a = Overall
b = Threaded section

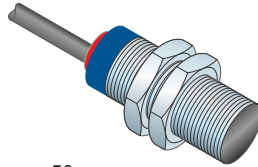

a = 50
b = 42

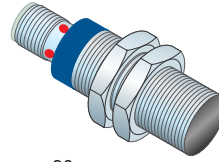

a = 60
b = 42

Nominal sensing distance (S _n)	5 mm	5 mm
--	------	------

References

2-wire $\overline{\overline{\text{---}}}$ (non polarised) Supply to :	Terminals 3-4 NO	XS1-M18DA210	XS1-M18DA210D
	Terminals 1-2 NC	XS1-M18DB210	–
Weight (kg)		0.120	0.060

Characteristics

Connection	Pre-cabled, 2 x 0.5 mm ² , length 2 m (1)	Connector (types 9, 10, 15, 16) (2)
Degree of protection	IP 68	Depending on connector (see pages 3/58 and 3/59)
Operating temperature	- 25...+ 80 °C	
Output state indication	LED, annular	LED, 4 viewing ports at 90°
Voltage limits (including ripple)	$\overline{\overline{\text{---}}}$ 10...58 V	
Switching capacity	1.5...100 mA with overload and short-circuit protection	
Voltage drop, closed state	≤ 5.2 V	
Current consumption, no-load	–	
Maximum switching frequency	350 Hz	

Wiring schemes

2-wire $\overline{\overline{\text{---}}}$, non polarised, NO or NC output

XS1-M18DA210/DA210D

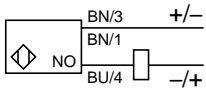

XS1-M18DB210

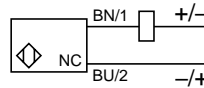

(1) Sensors pre-cabled with other cable lengths :

Length of cable	Suffix to be added to references stated above for 2 m pre-cabled sensors	Weight increase
5 m	L1	0.120 kg
10 m	L2	0.320 kg

Example : sensor **XS1-M18DA210** with 5 m cable becomes **XS1-M18DA210L1**

(2) The type numbers refer to suitable female connectors and extension cables, see pages 3/58 and 3/59.

Inductive proximity sensors

Cylindrical type, M18 x 1 threaded
Metal case (brass), form A
a.c. or d.c. supply

Accessories :
page 3/59

References, characteristics, dimensions, schemes

Flush mountable in metal

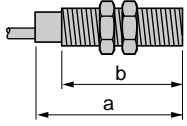

Lengths (mm) :
a = Overall
b = Threaded section

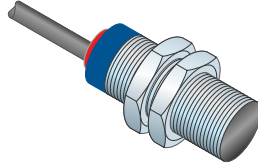

a = 60
b = 51.5

AC/DC

Nominal sensing distance (S_n)

5 mm

References

2-wire ~ or ---	NO	XS1-M18MA230
	NC	XS1-M18MB230
2-wire ~ or --- (protected against short-circuits)	NO	XS1-M18MA250
	NC	XS1-M18MB250
Weight (kg)		0.120

Characteristics

Connection	Pre-cabled, 2 x 0.5 mm ² , length 2 m (1)
Degree of protection	IP 68
Operating temperature	- 25...+ 80 °C
Output state indication	non protected model LED, annular
	protected model 1 red LED (output state), 1 green LED (supply and short-circuit indication)
Voltage limits (including ripple)	~ or --- 20...264 V
Switching capacity	(~) 5...300 mA or (---) 5...200 mA (2)
Voltage drop, closed state	≤ 5.5 V
Current consumption, no-load	–
Maximum switching frequency	(~) 25 Hz or (---) 200 Hz

Wiring schemes

2-wire ~ or ---, NO or NC output
XS1-M18M●230/250

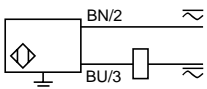

⊥ For connector version sensors

(1) Sensors pre-cabled with other cable lengths :

Length of cable	Suffix to be added to references stated above for 2 m pre-cabled sensors	Weight increase
5 m	L1	0.120 kg
10 m	L2	0.320 kg

Example : sensor **XS1-M18MA230** with 5 m cable becomes **XS1-M18MA230L1**

(2) For the sensors not incorporating overload or short-circuit protection, it is recommended that a 0.8 A “quick-blow” fuse be connected in series with the load.

Inductive proximity sensors

Cylindrical type, M30 x 1.5 threaded
Metal case (brass), short
d.c. supply

Accessories :
page 3/59

References, characteristics, dimensions, schemes

Flush mountable in metal

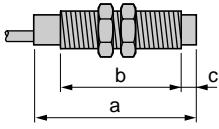

Lengths (mm) :
a = Overall
b = Threaded section
c = For non flush mounting sensors

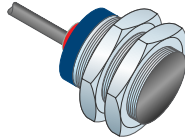

a = 40.5
b = 32

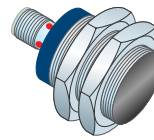

a = 50
b = 30

Nominal sensing distance (S _n)	10 mm	Increased range model 20 mm	10 mm	Increased range model 20 mm
--	-------	--------------------------------	-------	--------------------------------

References

3-wire ---	PNP	NO	XS1-N30PA340	XS1-N30PA349	XS1-N30PA340D	XS1-N30PA349D
	NPN	NO	XS1-N30NA340	XS1-N30NA349	XS1-N30NA340D	XS1-N30NA349D
Weight (kg)			0.160	0.160	0.100	0.100

Characteristics

Connection	Pre-cabled, 3 or 4 x 0.34 mm ² , length 2 m (1)		Connector (types 9, 10, 15, 16) (2)		Connector (types 9, 10, 11/12, 15, 16) (2)	
Degree of protection	IP 67		Depending on connector (see pages 3/58 and 3/59)			
Operating temperature	- 25...+ 70 °C	- 25...+ 50 °C	- 25...+ 70 °C	- 25...+ 50 °C		
Output state indication	LED, annular		LED, 4 viewing ports at 90°			
Voltage limits (including ripple)	--- 10...38 V (~ 24 V rectified and filtered)					
Switching capacity	0...200 mA with overload and short-circuit protection					
Voltage drop, closed state	≤ 2 V	≤ 2.6 V	≤ 2 V	≤ 2.6 V		
Current consumption, no-load	≤ 10 mA					
Maximum switching frequency	1000 Hz	15 Hz	1000 Hz	15 Hz		

Wiring schemes

3-wire ---, NO output
XS1/XS2-N30●340/340D/349/349D



(1) Sensors pre-cabled with other cable lengths :

Length of cable	Suffix to be added to references stated above for 2 m pre-cabled sensors	Weight increase
5 m	L1	0.120 kg
10 m	L2	0.320 kg

Example : sensor XS1-N30PA340 with 5 m cable becomes XS1-N30PA340L1

(2) The type numbers refer to suitable female connectors and extension cables, see pages 3/58 and 3/59.

Non flush mountable in metal

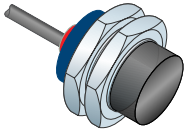

a = 40.5
b = 19
c = 13

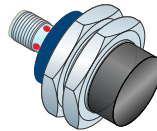

a = 50
b = 19
c = 13

15 mm	15 mm
-------	-------

XS2-N30PA340	XS2-N30PA340D
XS2-N30NA340	XS2-N30NA340D
0.160	0.100

Pre-cabled, 3 or 4 x 0.34 mm², length 2 m (1)	Connector (types 9, 10, 15, 16) (2)
IP 67	Depending on connector (see pages 3/58 and 3/59)
- 25...+ 70 °C	
LED, annular	LED, 4 viewing ports at 90°
⎓ 10...38 V (~ 24 V rectified and filtered)	
0...200 mA with overload and short-circuit protection	
≤ 2 V	
≤ 10 mA	
1000 Hz	

Inductive proximity sensors

Cylindrical type, M30 x 1.5 threaded
Metal case (brass), form A
d.c. supply

Accessories :
page 3/59

References, characteristics, dimensions, schemes

Flush mountable in metal

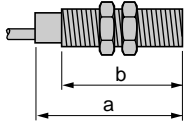

Lengths (mm) :
a = Overall
b = Threaded section

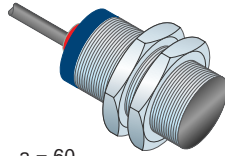

a = 60
b = 51.5

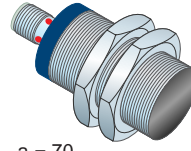

a = 70
b = 51.5

Nominal sensing distance (Sn)	10 mm	10 mm	10 mm	10 mm
-------------------------------	-------	-------	-------	-------

References

3-wire ---	PNP	NO	XS1-M30PA370	–	XS1-M30PA370D	–
	NPN	NO	XS1-M30NA370	–	XS1-M30NA370D	–
4-wire --- universal model	PNP/NPN programmable	NO/NC	–	XS1-M30KP340	–	XS1-M30KP340D
Weight (kg)			0.205	0.205	0.145	0.145

Characteristics

Connection	Pre-cabled, 3 x 0.34 mm ² , length 2 m (1)		Connector (types 9, 10, 15, 16) (2)	
Degree of protection	IP 68		Depending on connector (see pages 3/58 and 3/59)	
Operating temperature	- 25...+ 80 °C			
Output state indication	LED, annular		LED, 4 viewing ports at 90°	
Voltage limits (including ripple)	--- 10...58 V (3)	--- 10...38 V (4)	--- 10...58 V (3)	--- 10...38 V (4)
Switching capacity	0...200 mA with overload and short-circuit protection			
Voltage drop, closed state	≤ 2 V	≤ 2.6 V	≤ 2 V	≤ 2.6 V
Current consumption, no-load	≤ 10 mA			
Maximum switching frequency	1000 Hz			

Wiring schemes

3-wire ---, NO output
XS1-M30●●370/370D

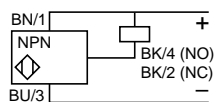
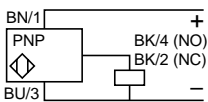

4-wire --- programmable, NO or NC output
XS1-M30KP340/340D

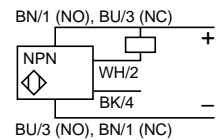
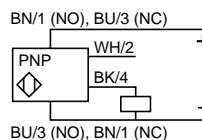

(1) Sensors pre-cabled with other cable lengths :

Length of cable	Suffix to be added to references stated above for 2 m pre-cabled sensors	Weight increase
5 m	L1	0.120 kg
10 m	L2	0.320 kg

Example : sensor **XS1-M30PA370** with 5 m cable becomes **XS1-M30PA370L1**

(2) The type numbers refer to suitable female connectors and extension cables, see pages 3/58 and 3/59.

(3) Can be supplied with rectified ~ 24 V.

(4) ~ 24 V rectified and filtered.

Inductive proximity sensors

Cylindrical type, M30 x 1.5 threaded
Metal case (brass), form A
d.c. supply (continued)

Accessories :
page 3/59

References, characteristics, dimensions, schemes

Non flush mountable in metal

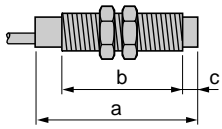

Lengths (mm) :
a = Overall
b = Threaded section
c = For non flush mounting sensors

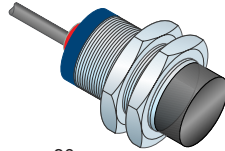

a = 60
b = 38.5
c = 13

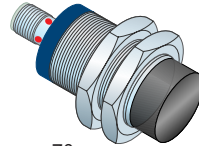

a = 70
b = 38.5
c = 13

Nominal sensing distance (S _n)	15 mm	15 mm	15 mm	15 mm
--	-------	-------	-------	-------

References

3-wire ---	PNP	NO	XS2-M30PA370	–	XS2-M30PA370D	–
	NPN	NO	XS2-M30NA370	–	XS2-M30NA370D	–
4-wire --- universal model	PNP/NPN programmable	NO/NC	–	XS2-M30KP340	–	XS2-M30KP340D
Weight (kg)			0.205	0.205	0.145	0.145

Characteristics

Connection	Pre-cabled, 3 x 0.34 mm ² , length 2 m (1)	Connector (types 9, 10, 15, 16) (2)	
Degree of protection	IP 68	Depending on connector (see pages 3/58 and 3/59)	
Operating temperature	- 25...+ 80 °C		
Output state indication	LED, annular	LED, 4 viewing ports at 90°	
Voltage limits (including ripple)	--- 10...58 V (3)	--- 10...38 V (4)	--- 10...58 V (3) --- 10...38 V (4)
Switching capacity	0...200 mA with overload and short-circuit protection		
Voltage drop, closed state	≤ 2 V	≤ 2.6 V	≤ 2 V ≤ 2.6 V
Current consumption, no-load	≤ 10 mA		
Maximum switching frequency	1000 Hz		

Wiring schemes

3-wire ---, NO output
XS2-M30●●370/370D

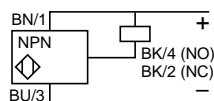
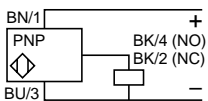

4-wire --- programmable, NO or NC output
XS2-M30KP340/340D

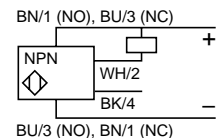
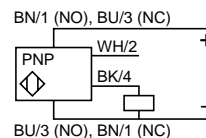

(1) Sensors pre-cabled with other cable lengths :

Length of cable	Suffix to be added to references stated above for 2 m pre-cabled sensors	Weight increase
5 m	L1	0.120 kg
10 m	L2	0.320 kg

Example : sensor XS2-M30PA370 with 5 m cable becomes XS2-M30PA370L1

(2) The type numbers refer to suitable female connectors and extension cables, see pages 3/58 and 3/59.

(3) Can be supplied with rectified ~ 24 V.

(4) ~ 24 V rectified and filtered.

Inductive proximity sensors

Cylindrical type, M30 x 1.5 threaded
Metal case (brass), form A
a.c. or d.c. supply

Accessories :
page 3/59

References, characteristics, dimensions, schemes

Flush mountable in metal

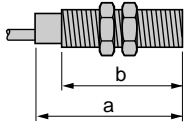

Lengths (mm) :
a = Overall
b = Threaded section

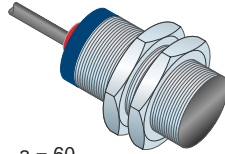

a = 60
b = 51.5

AC/DC

Nominal sensing distance (S_n)

10 mm

References

2-wire ~ or ---	NO	XS1-M30MA230
	NC	XS1-M30MB230
2-wire ~ or --- (protected against short-circuits)	NO	XS1-M30MA250
	NC	XS1-M30MB250
Weight (kg)		0.205

Characteristics

Connection	Pre-cabled, 2 x 0.5 mm ² , length 2 m (1)	
Degree of protection	IP 68	
Operating temperature	- 25...+ 80 °C	
Output state indication	non protected model	LED, annular
	protected model	1 red LED (output state), 1 green LED (supply and short-circuit indication)
Voltage limits (including ripple)	~ or --- 20...264 V	
Switching capacity	(~) 5...300 mA or (---) 5...200 mA (2)	
Voltage drop, closed state	≤ 5.5 V	
Current consumption, no-load	–	
Maximum switching frequency	(~) 25 Hz or (---) 100 Hz	

Wiring schemes

2-wire ~ or ---, NO or NC output
XS1-M30M●230/250

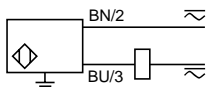

⏏ For connector version sensors

(1) Sensors pre-cabled with other cable lengths :

Length of cable	Suffix to be added to references stated above for 2 m pre-cabled sensors	Weight increase
5 m	L1	0.120 kg
10 m	L2	0.320 kg

Example : sensor **XS1-M30MA230** with 5 m cable becomes **XS1-M30MA230L1**

(2) For the sensors not incorporating overload or short-circuit protection, it is recommended that a 0.8 A “quick-blow” fuse be connected in series with the load.

Inductive proximity sensors

Cylindrical type, M30 x 1.5 threaded
Metal case (brass), form A
a.c. or d.c. supply (continued)

Accessories :
page 3/59

References, characteristics, dimensions, schemes

Non flush mountable in metal

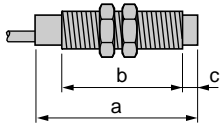

Lengths (mm) :
a = Overall
b = Threaded section
c = For non flush mounting sensors

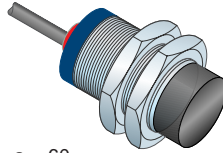

a = 60
b = 38.5
c = 13
AC/DC

Nominal sensing distance (S_n)	15 mm
---	--------------

References

2-wire ~ or ---	NO	XS2-M30MA230
	NC	XS2-M30MB230
2-wire ~ or --- (protected against short-circuits)	NO	XS2-M30MA250
	NC	XS2-M30MB250
Weight (kg)	0.205	

Characteristics

Connection	Pre-cabled, 2 x 0.5 mm², L = 2 m (1)						
Degree of protection	IP 68						
Operating temperature	- 25...+ 80 °C						
Output state indication	<table border="0"> <tr> <td>non protected model</td> <td>LED, annular</td> </tr> <tr> <td></td> <td>1 red LED (output state)</td> </tr> <tr> <td>protected model</td> <td>1 green LED (supply and short-circuit indication)</td> </tr> </table>	non protected model	LED, annular		1 red LED (output state)	protected model	1 green LED (supply and short-circuit indication)
non protected model	LED, annular						
	1 red LED (output state)						
protected model	1 green LED (supply and short-circuit indication)						
Voltage limits (including ripple)	~ or --- 20...264 V						
Switching capacity	(~) 5...300 mA or (---) 5...200 mA (2)						
Voltage drop, closed state	≤ 5.5 V						
Current consumption, no-load	–						
Maximum switching frequency	(~) 25 Hz or (---) 75 Hz						

Wiring schemes

2-wire ~ or ---, NO or NC output
XS2-M30●●2●0

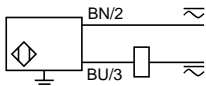

⊥ For connector version sensors

(1) Sensors pre-cabled with other cable lengths :

Length of cable	Suffix to be added to references stated above for 2 m pre-cabled sensors	Weight increase
5 m	L1	0.120 kg
10 m	L2	0.320 kg

Example : sensor **XS2-M30MA230** with 5 m cable becomes **XS2-M30MA230L1**

(2) For the sensors not incorporating overload or short-circuit protection, it is recommended that a 0.8 A "quick-blow" fuse be connected in series with the load.

Inductive proximity sensors

Compact block (12 x 26 x 40 mm), plastic, type XSG
a.c. or d.c. supply

References, characteristics, schemes

Accessories :
page 3/59

	Flush mountable in metal	Non flush mountable in metal
--	--------------------------	------------------------------



Nominal sensing distance (S _n)	2 mm	4 mm
--	------	------

References

4-wire --- (complementary outputs)	PNP	NO + NC	XSG-H027330	XSG-H047330
	NPN	NO + NC	XSG-J027330	XSG-J047330
Weight (kg)			0.180	0.180

Characteristics

Connection	Pre-cabled, length 2 m (1) 4 x 0.34 mm ²	
Degree of protection	IP 65	
Operating temperature	- 25...+ 70 °C	
Output state indication	LED, at rear	
Voltage limits (including ripple)	--- 10...58 V	
Switching capacity	0...200 mA (2)	
Voltage drop, closed state	≤ 1.8 V	
Current consumption, no-load	≤ 10 mA	
Maximum switching frequency	1000 Hz	800 Hz

Wiring schemes

4-wire ---
NO + NC output

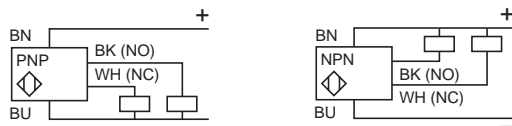

(1) Sensors pre-cabled with other cable lengths :

Length of cable	Suffix to be added to references stated above for 2 m pre-cabled sensors	Weight increase
5 m	L05	0.120 kg
10 m	L10	0.320 kg

Example : sensor **XSG-H027330** with 5 m cable becomes **XSG-H027330L05**

(2) With overload and short-circuit protection.

Inductive proximity sensors

Plug-in compact block (41 x 50 x 76 mm), plastic, type XSB
a.c. or d.c. supply

References, characteristics, schemes

Accessories :
page 3/59

Non flush mountable in metal

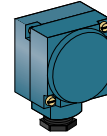
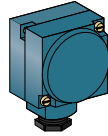

	DC	AC
Nominal sensing distance (S _n)	25 mm	25 mm

References

2-wire $\overline{\sim}$	NO	XSB-C25710	–
2-wire \sim	NO	–	XSB-A25911
	NC	–	XSB-A25921
Weight (kg)	0.190		0.190

Characteristics

Connection	Screw terminals, capacity : 2 x 1.5 mm ²	
Degree of protection	IP 67	
Operating temperature	- 25... + 70 °C	
Output state indication	–	LED
Voltage limits (including ripple)	$\overline{\sim}$ 12...58 V	\sim 93...264 V
Switching capacity (1)	1.5...80 mA	20...150 mA
Voltage drop, closed state	≤ 7 V	≤ 9.5 V
Current consumption, no-load	–	–
Maximum switching frequency	250 Hz	40 Hz

Wiring schemes

2-wire $\overline{\sim}$
NO output

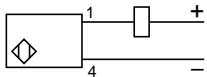

2-wire \sim
NO output

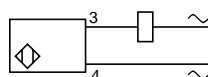

NC output

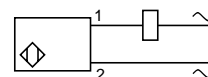

(1) For XSB-A (\sim) sensors, not incorporating overload or short-circuit protection, it is recommended that a 0.63 A "quick-blow" fuse be connected in series with the load.

Inductive proximity sensors

Plug-in block form C (41 x 40 x 117 mm), plastic, type XS7
5 position turret head
d.c. supply

Accessories :
page 3/59

References, characteristics, schemes

Flush mountable in metal

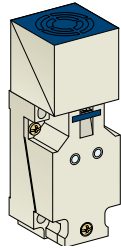

Nominal sensing distance (S _n)	15 mm	Increased range model 20 mm	15 mm
--	-------	--------------------------------	-------

References

4-wire $\overline{\text{---}}$ (complementary outputs)	PNP	NO + NC	XS7-C40PC440H29	XS7-C40PC449H29	–
	NPN	NO + NC	XS7-C40NC440H29	XS7-C40NC449H29	–
2-wire $\overline{\text{---}}$ (non polarised)	NO		–	–	XS7-C40DA210H29
	NO or NC programmable		–	–	XS7-C40DP210H29
Weight (kg)			0.220	0.220	0.220

Characteristics

Connection	Screw terminals, capacity : 2 or 4 x 1.5 mm ²	
Degree of protection	IP 67	
Operating temperature	- 25...+ 70 °C	
Supply/output state indication	Output LED + Supply LED	Output LED
Voltage limits (including ripple)	$\overline{\text{---}}$ 10...58 V	
Switching capacity (with overload and short-circuit protection)	0...200 mA	1.5...100 mA
Voltage drop, closed state	≤ 2 V	≤ 5.2 V
Current consumption, no-load	≤ 10 mA	–
Maximum switching frequency	1000 Hz	150 Hz

Wiring schemes

2-wire $\overline{\text{---}}$ (non polarised)
NO or NC output
depending on position of link

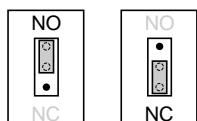
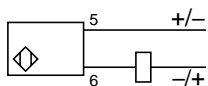

4-wire $\overline{\text{---}}$
NO + NC output

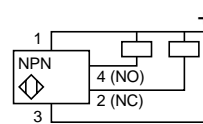
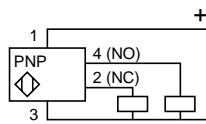

Inductive proximity sensors

Plug-in block form C (41 x 40 x 117 mm), plastic, type XS8
5 position turret head
d.c. supply

Accessories :
page 3/59

References, characteristics, schemes

Non flush mountable in metal

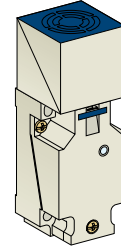
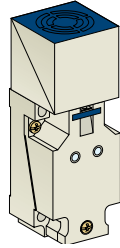

Nominal sensing distance (S _n)	20 mm	Increased range model 40 mm	20 mm
--	-------	--------------------------------	-------

References

4-wire \equiv (complementary outputs)	PNP	NO + NC	XS8-C40PC440H29	XS8-C40PC449H29	–
	NPN	NO + NC	XS8-C40NC440H29	XS8-C40NC449H29	–
2-wire \equiv (non polarised)	NO or NC programmable		–	–	XS8-C40DP210H29
Weight (kg)			0.220	0.220	0.220

Characteristics

Connection	Screw terminals, capacity : 2 or 4 x 1.5 mm ²		
Degree of protection	IP 67		
Operating temperature	- 25...+ 70 °C		
Supply/output state indication	Output LED + Supply LED		Output LED
Voltage limits (including ripple)	\equiv 10...58 V		
Switching capacity (with overload and short-circuit protection)	0...200 mA		1.5...100 mA
Voltage drop, closed state	≤ 2 V		≤ 5.2 V
Current consumption, no-load	≤ 10 mA		–
Maximum switching frequency	1000 Hz	500 Hz	100 Hz

Wiring schemes

2-wire \equiv (non polarised)
NO or NC output
depending on position of link

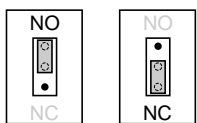
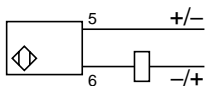

4-wire \equiv
NO + NC output

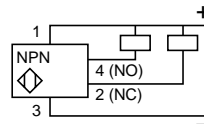
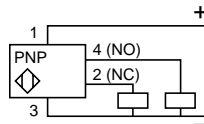

Inductive proximity sensors

Plug-in block form C (41 x 40 x 117 mm), plastic, types XS7 and XS8
5 position turret head
a.c. or d.c. supply

Accessories :
pages 3/59

References, characteristics, schemes

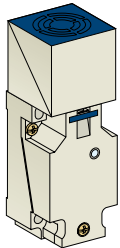
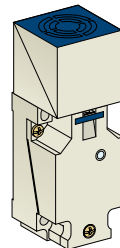
	Flush mountable in metal	Non flush mountable in metal
		
	AC	AC
	AC/DC	AC/DC
Nominal sensing distance (S_n)	15 mm	20 mm

References

2-wire ~	NO/NC programmable	XS7-C40FP260H29	–	XS8-C40FP260H29	–
2-wire ~ or ≡ universal model	NO/NC programmable	–	XS7-C40MP230H29	–	XS8-C40MP230H29
Weight (kg)		0.220	0.220	0.220	0.220

Characteristics

Connection	Screw terminals, capacity : 2 x 1.5 mm²			
Degree of protection	IP 67			
Operating temperature	- 25...+ 70 °C			
Supply/output state indication	Output LED			
Voltage limits	~ 20...264 V	~ or ≡ 20...264 V	~ 20...264 V	~ or ≡ 20...264 V
Switching capacity	5...500 mA (1)(2 A inrush)	~ 5...300 mA or ≡ 5...200 mA (1)	5...500 mA (1)(2 A inrush)	~ 5...300 mA or ≡ 5...200 mA (1)
Voltage drop, open state	≤ 5.5 V			
Current consumption, no-load	–			
Maximum switching frequency	25 Hz	~ 25 Hz, ≡ 50 Hz	25 Hz	~ 25 Hz, ≡ 50 Hz

Wiring schemes

2-wire ~ programmable
NO or NC output depending on position of link

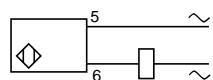

2-wire ~ or ≡ programmable
NO or NC output depending on position of link

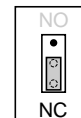
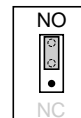
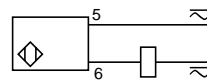

(1) These sensors do not incorporate overload or short-circuit protection and therefore, it is recommended that a 0.8 A “quick-blow” fuse be connected in series with the load.

Inductive proximity sensors

Plug-in block form D (40 x 80 x 100 mm), plastic, type XSD
d.c. supply and a.c./d.c. supply

References, characteristics, schemes

Accessories :
page 3/59

Non flush mountable in metal

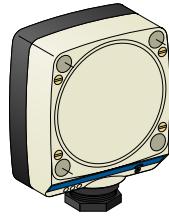

DC

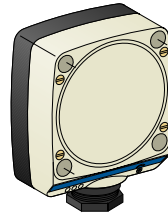

AC/DC

Nominal sensing distance (S_n)	30...60 mm (1)
---	----------------

References

4-wire $\overline{\text{---}}$ (complementary outputs)	PNP	NO + NC	XSD-H607339	–
2-wire \sim or $\overline{\text{---}}$ universal model		NO or NC programmable	–	XSD-M600539
Weight (kg)			0.480	0.480

Characteristics

Connection	Screw terminals, capacity : 2 x 1.5 mm ²	
Degree of protection	IP 67	
Operating temperature	- 25...+ 70 °C	
Supply/output state indication	Output LED	Output LED + Supply LED + Short-circuit LED
Voltage limits (including ripple)	$\overline{\text{---}}$ 10...58 V	\sim or $\overline{\text{---}}$ 20...264 V
Switching capacity (with overload and short-circuit protection)	0...200 mA	($\overline{\text{---}}$) 5...100 mA or (\sim) 5...500 mA
Voltage drop, closed state	≤ 1.8 V	≤ 6 V
Current consumption, no-load	≤ 10 mA	–
Maximum switching frequency	20 Hz	10 Hz

Wiring schemes

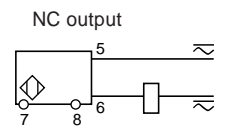
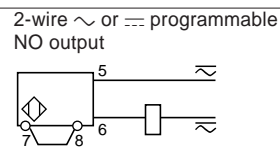
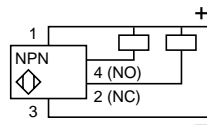
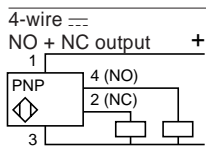

- (1) XSD-60 sensors incorporate a sensing distance adjustment potentiometer. This enables adjustment to suit the following requirements :
- limiting the effects of surrounding objects (by decreasing the sensing distance),
 - increasing the sensing distance up to 48 mm, using a standard mild steel target. Settings above 48 mm are not recommended.

Inductive proximity sensors

Analogue output models
Cylindrical type, M12 x 1 threaded, metal or plastic case
Pre-cabled with 2 m cable

Accessories :
page 3/59

References, characteristics, dimensions, schemes

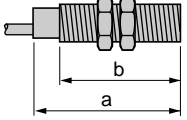
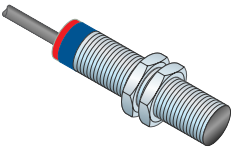
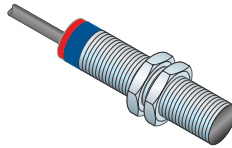
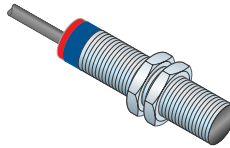
	Flush mountable in metal	Non flush mountable in metal	
 <p>Lengths (mm) : a = Overall b = Threaded section</p>	 <p>a = 50 b = 42</p> <p>Metal case</p>	 <p>a = 50 b = 42</p> <p>Plastic case</p>	 <p>a = 50 b = 42</p> <p>Plastic case</p>
Nominal sensing distance (S_n)	0.2...2 mm	0.4...4 mm	0.4...4 mm

References

3-wire ---	Output	0...10 mA (1) 4...14 mA (2)	–	–	XS4-P12AB110
	Output	4...20 mA (2) 0...16 mA (1)	XS1-M12AB120	XS4-P12AB120	–
Weight (kg)		0.075	0.065	0.065	

Characteristics

Connection	Pre-cabled, 3 x 0.34 mm², length 2 m		
Degree of protection	IP 67		
Ambient air temperature	Operation : - 25...+ 70 °C		
Voltage limits (including ripple)	--- 15...38 V	--- 15...38 V	--- 15...58 V
Output current drift θ ambient : - 25...+ 70 °C	≤ 10 %		
Current consumption, no-load	4 mA		

(1) Output current range for "3-wire" connection, see schemes below.
(2) Output current range for "2-wire" connection, see schemes below.

Wiring schemes

2-wire connection

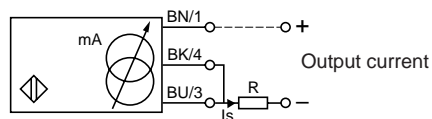

Output current	Value of R (R = load impedance)
24 V 4...14 mA	≤ 640 Ω
4...20 mA	≤ 450 Ω
48 V 4...14 mA	≤ 2350 Ω

Ensure a minimum of 15 V between the + (1) and - (3) terminals of the sensor

3-wire connection

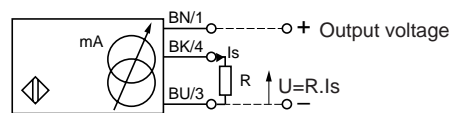

Output current	Value of R (R = load impedance)
24 V 0...10 mA	≤ 1800 Ω
0...16 mA	≤ 1125 Ω
48 V 0...10 mA	≤ 4200 Ω

Ensure a minimum of 5 V between the + and sensor output (terminal 4)

Other versions

"Original equipment" range Ø 12 mm sensors with analogue output (XSP-H●●●62).
Please consult your Regional customer centre.

Inductive proximity sensors

Analogue output models
Cylindrical type, M18 x 1 threaded, metal or plastic case
Pre-cabled with 2 m cable

Accessories :
page 3/59

References, characteristics, dimensions, schemes

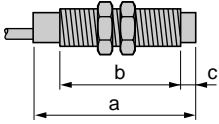
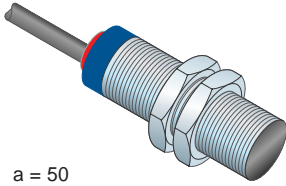
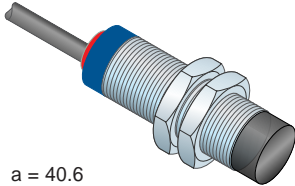
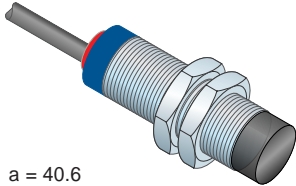
	Flush mountable in metal	Non flush mountable in metal	
 <p>Lengths (mm) : a = Overall b = Threaded section c = For non flush mounting sensors</p>	 <p>a = 50 b = 42 c = 0 Metal case</p>	 <p>a = 40.6 b = 26 c = 8 Plastic case</p>	 <p>a = 40.6 b = 26 c = 8 Plastic case</p>
Nominal sensing distance (S_n)	0.5...5 mm	0.8...8 mm	0.8...8 mm

References

3-wire ---	Output	0...10 mA (1) 4...14 mA (2)	-	-	XS4-P18AB110
	Output	4...20 mA (2) 0...16 mA (1)	XS1-M18AB120	XS4-P18AB120	-
Weight (kg)		0.120	0.080	0.080	

Characteristics

Connection	Pre-cabled, 3 x 0.34 mm², length 2 m
Degree of protection	IP 67
Ambient air temperature	Operation : - 25...+ 70 °C
Voltage limits (including ripple)	--- 15...38 V
Output current drift θ ambient : - 25...+ 70 °C	≤ 10 %
Current consumption, no-load	4 mA

1) Output current range for "3-wire" connection, see schemes below.
2) Output current range for "2-wire" connection, see schemes below.

Wiring schemes

2-wire connection

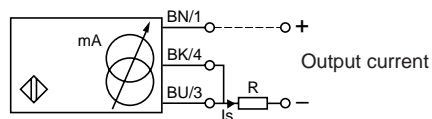

Output current	Value of R (R = load impedance)
24 V 4...14 mA	≤ 640 Ω
4...20 mA	≤ 450 Ω
48 V 4...14 mA	≤ 2350 Ω

Ensure a minimum of 15 V between the + (1) and - (3) terminals of the sensor

3-wire connection

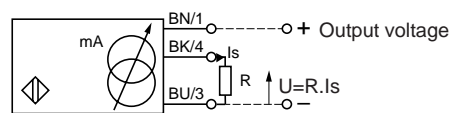

Output current	Value of R (R = load impedance)
24 V 0...10 mA	≤ 1800 Ω
0...16 mA	≤ 1125 Ω
48 V 0...10 mA	≤ 4200 Ω

Ensure a minimum of 5 V between the + and sensor output (terminal 4)

Other versions

"Original equipment" range Ø 18 mm sensors with analogue output (XSP-H●●●62).
Please consult your Regional customer centre.

Inductive proximity sensors

Analogue output models
Cylindrical type, M30 x 1.5 threaded, metal or plastic case
Pre-cabled with 2 m cable

Accessories :
page 3/59

References, characteristics, dimensions, schemes

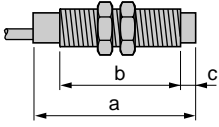
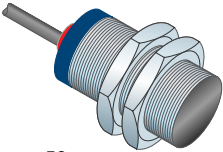
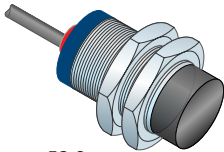
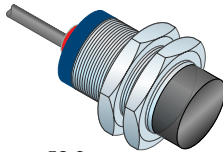
	Flush mountable in metal	Non flush mountable in metal	
 <p>Lengths (mm) : a = Overall b = Threaded section c = For non flush mounting sensors</p>	 <p>a = 50 b = 42 c = 0 Metal case</p>	 <p>a = 52.6 b = 32 c = 13 Plastic case</p>	 <p>a = 52.6 b = 32 c = 13 Plastic case</p>
Nominal sensing distance (S_n)	1...10 mm	1.5...15 mm	1.5...15 mm

References

3-wire ---	Output	0...10 mA (1) 4...14 mA (2)	-	-	XS4-P30AB110
	Output	4...20 mA (2) 0...16 mA (1)	XS1-M30AB120	XS4-P30AB120	-
Weight (kg)		0.200	0.100	0.100	

Characteristics

Connection	Pre-cabled, 3 x 0.34 mm², length 2 m
Degree of protection	IP 67
Ambient air temperature	Operation : - 25...+ 70 °C
Voltage limits (including ripple)	--- 15...38 V
Output current drift θ ambient : - 25...+ 70 °C	≤ 10 %
Current consumption, no-load	4 mA

(1) Output current range for "3-wire" connection, see schemes below.
(2) Output current range for "2-wire" connection, see schemes below.

Wiring schemes

2-wire connection

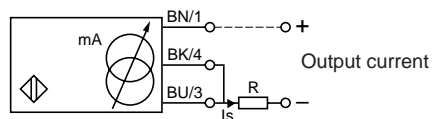

Output current	Value of R (R = load impedance)
24 V 4...14 mA	≤ 640 Ω
4...20 mA	≤ 450 Ω
48 V 4...14 mA	≤ 2350 Ω

Ensure a minimum of 15 V between the + (1) and - (3) terminals of the sensor

3-wire connection

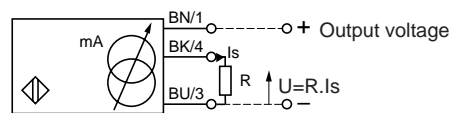

Output current	Value of R (R = load impedance)
24 V 0...10 mA	≤ 1800 Ω
0...16 mA	≤ 1125 Ω
48 V 0...10 mA	≤ 4200 Ω

Ensure a minimum of 5 V between the + and sensor output (terminal 4)

Inductive proximity sensors

For specific applications : rotation monitoring
Cylindrical type, metal case

References, characteristics, dimensions, schemes

Accessories :
page 3/59

Flush mountable in metal

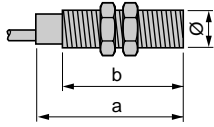

Lengths (mm) :
a = Overall
b = Threaded section

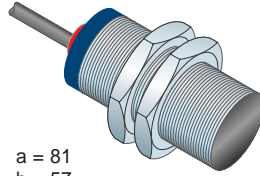

a = 81
b = 57
Ø = M30 x 1.5

Nominal sensing distance (S _n)	10 mm	10 mm	10 mm
--	-------	-------	-------

References

3-wire \equiv PNP	Impulses/minute 6...150	XSA-V11373	-	-
	120...3000	XSA-V12373	-	-
2-wire \sim	Impulses/minute 6...150	-	XSA-V11151	XSA-V11161
	120...3000	-	XSA-V12151	XSA-V12161
Weight (kg)	0.300	0.300	0.300	0.300

Characteristics

Connection (2)	Pre-cabled, 3 x 0.34 mm ² , length 2 m	Pre-cabled, 2 x 0.5 mm ² , length 2 m	
Degree of protection	IP 67		
Operating temperature (1)	- 25...+ 70 °C		
Output state indication	LED		
Voltage limits (including ripple)	\equiv 10...58 V	\sim 93...132 V	\sim 187...264 V
Switching capacity	0...200 mA with overload & short-circuit protection	20...350 mA (2 A inrush)	
Voltage drop, closed state	≤ 1.8 V	≤ 4.5 V	
Current consumption, no-load	≤ 10 mA	-	
Maximum switching frequency	6000 impulses/minute (for XSA-V11●●●) ; 48,000 impulses/minute (for XSA-V12 ●●●)		

Wiring schemes

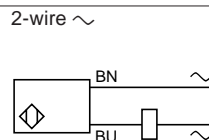
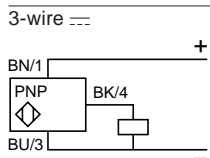

(1) Other operating temperature ranges : - 40...+ 70 °C (To order, add suffix **TF** to above refs.), - 25...+ 85 °C (To order, add suffix **TT** to above refs.).

(2) Sensors pre-cabled with other cable lengths :

Length of cable	Suffix to be added to references stated above	Weight increase
5 m	L05	0.120 kg
10 m	L10	0.320 kg

Example : sensor XSA-V11373 with 5 m cable becomes XSA-V11373L05

Other versions

Sensors without initial "run-up" delay, or with reduced "run-up" delay on energisation of 3 seconds.
SX2-DV units for monitoring overspeed or underspeed conditions, in the range 0 to 6000 impulses/minute.
Please consult your Regional customer centre.

Inductive proximity sensors

Female connectors

References, characteristics, dimensions, schemes

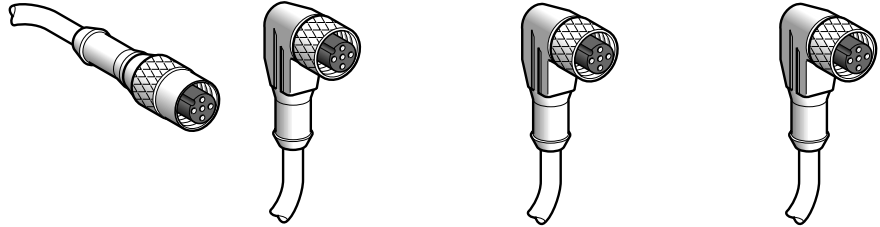

Connector type N°	9	10	11	12
Number of pins	4	4	4	4
Female connector version	M12 straight	M12 elbowed	M12 elbowed	M12 elbowed

References

PVR cable connection, Ø 5 mm	L = 2 m	XZ-CP1141L2	XZ-CP1241L2	XZ-CP1340L2	XZ-CP1440L2
	L = 5 m	XZ-CP1141L5	XZ-CP1241L5	XZ-CP1340L5	XZ-CP1440L5
	L = 10 m	XZ-CP1141L10	XZ-CP1241L10	XZ-CP1340L10	XZ-CP1440L10
Weight (kg)	0.090 (L = 2 m), 0.190 (L = 5 m), 0.370 (L = 10 m) 0.080 (L = 2 m), 0.180 (L = 5 m), 0.350 (L = 10 m)				

Characteristics

Wiring configuration, PNP/NPN	–	–	PNP wiring	NPN wiring
Degree of protection	IP 67	IP 67	IP 67	IP 67
Ambient air temperature	-35...+80 °C	-35...+80 °C	-35...+80 °C	-35...+80 °C
Number of wires and c.s.a.	4 x 0.25 mm ²	4 x 0.25 mm ²	3 x 0.25 mm ²	3 x 0.25 mm ²
LED indication	No	No	2 LEDs	2 LEDs
Associated sensor references	XS●-●●●●●●●●D	XS●-●●●●●●●●D	XS●-●●●●●●●●D	XS●-●●●●●●●●D

Dimensions

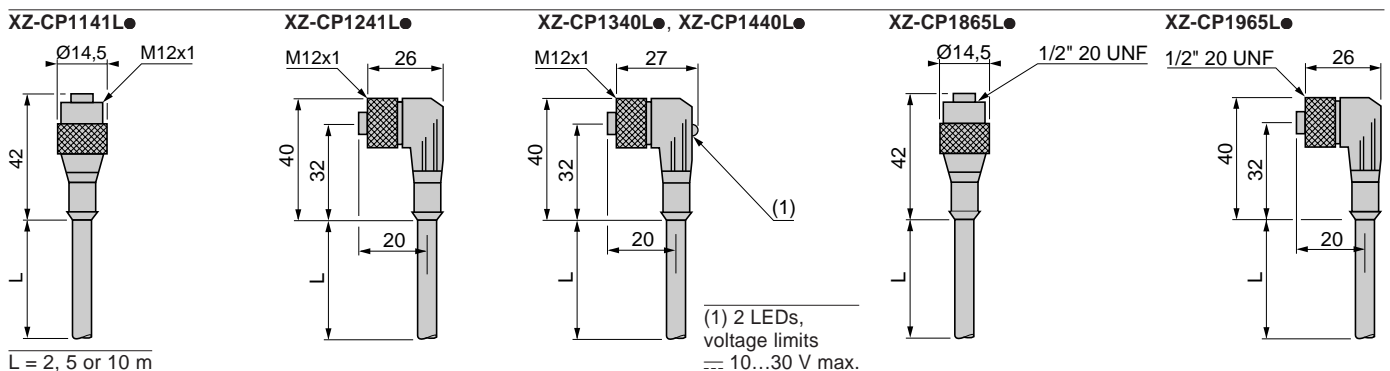

Connection schemes

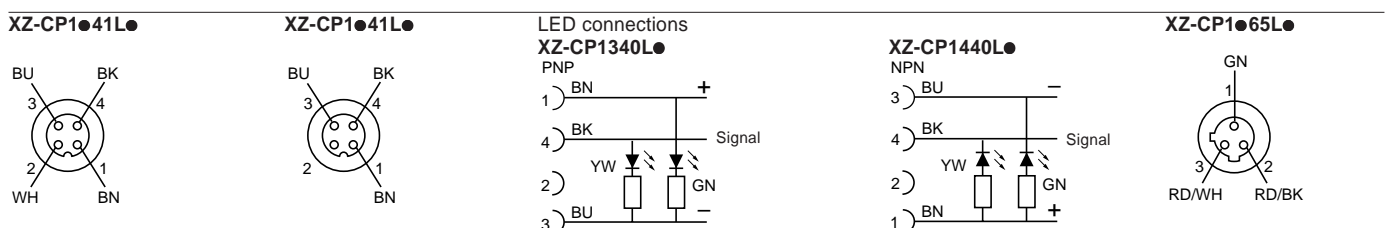

3

Inductive proximity sensors

Female connectors (continued) and sensor fixing accessory

References, characteristics, dimensions, schemes

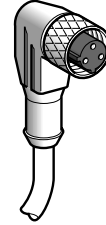
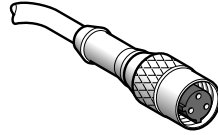

Connector type N°	13	14
Number of pins	3	3
Female connector version	1/2" 20 UNF straight	1/2" 20 UNF straight

References

PVR cable connection, Ø 5 mm	L = 2 m	XZ-CP1865L2	XZ-CP1965L2
	L = 5 m	XZ-CP1865L5	XZ-CP1965L5
	L = 10 m	XZ-CP1865L10	XZ-CP1965L10
Weight (kg)	0.080 (L = 2 m), 0.180 (L = 5 m), 0.350 (L = 10 m)		

Characteristics

Wiring configuration, PNP/NPN	–	–
Degree of protection	IP 67	IP 67
Ambient air temperature	-35...+80 °C	-35...+80 °C
Number of wires and c.s.a.	3 x 0.34 mm ²	3 x 0.34 mm ²
LED indication	No	No
Associated sensor references	XS●-●●●●●●●●K	XS●-●●●●●●●●K

Dimensions and connection schemes

Shown on previous page

Saddle clamp fixing accessory for cylindrical type sensors

Description	For use with sensors		Reference	Weight kg
	Type	Diameter (mm)		
Saddle clamps	XS1	4 (plain)	XSZ-B104	0.005
		5 (M5 x 0.5)	XSZ-B105	0.005
	XS1, XS2	6.5 (plain)	XSZ-B165	0.005
	XS1, XS2, XS4	8 (M8 x 1)	XSZ-B108	0.006
		12 (M12 x 1)	XSZ-B112	0.006
		18 (M18 x 1)	XSZ-B118	0.010
XS1, XS2, XS4	30 (M30 x 1.5)	XSZ-B130	0.020	

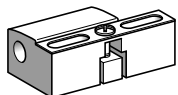

XSZ-B1●●