

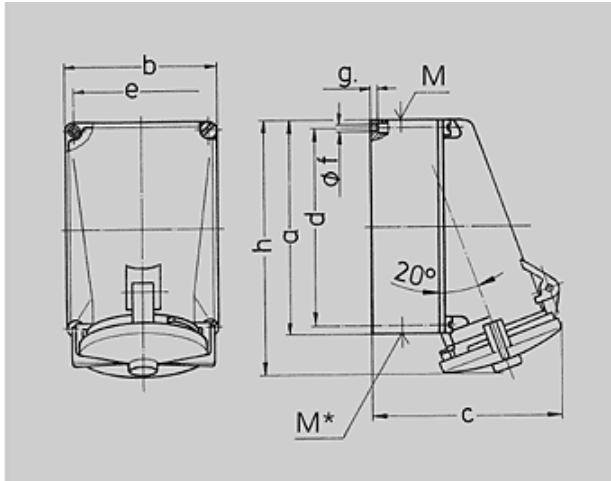

N° de Ref. : 140

Base

1 MB 162	Amp.	125		
1 MB 163	Polos	4	5	
Dim. en mm	a	264	264	
	b	163	163	
	c	203	203	
	d	240	240	
	e	140	140	
	f	8,1	8,1	
	g	8	8	
	h	313	313	
	M	50	50	
	M*	50	50	
	Diám. máx. de cable (mm)		38	38
	Borna para cond. Sección Transvers. (mm ²) min.-máx.		25	25
			—35	—35

 Grupo de artículos : **1050**

voltages : 500V

rated current : 125A

pole : 4 pole







IP protection types : IP67

position of ground contact : 7h

packing unit : 0003

Peso : 1910 g

N° DE REF.

V	110V	230V	400V	500V	>50-500V	
Hz	50,60	50,60	50,60	50,60	100-300	300-500
Color código						
Amperios						
125 A	4	137	138	139	<u>140</u>	
	5	141	142	143	2139	