



N° de Ref. : 205A

Base semiempotrable

inclinación 63A 20°, 125A 15°

*) 63A: con SoftCONTACT,

125A: contacto de muelle de torsión

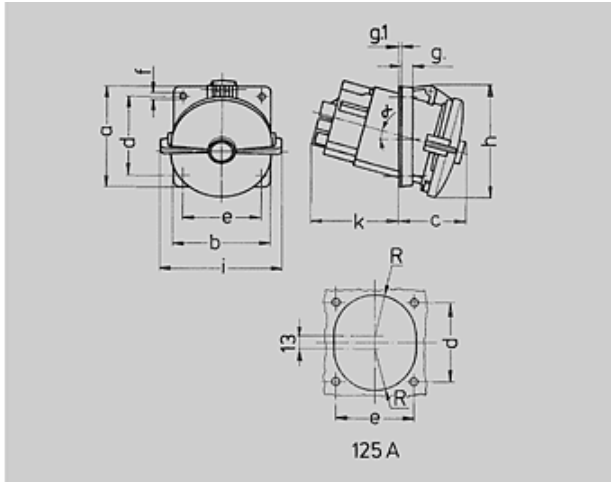

1 MB 298 1 MB 339	Amp. Polos	63			125		
		3	4	5	3	4	5
Dim. en mm	a	110	110	110	114	114	114
	b	106	106	106	110	110	110
	c	85	85	85	85	85	85
	d	85	85	85	90	90	90
	e	77	77	77	90	90	90
	f	6,2	6,2	6,2	6,2	6,2	6,2
	g	12	12	12	13	13	13
	g ₁	2	2	2	2	2	2
	h	125	125	125	135	135	135
	i	117	117	117	135	135	135
	k	69	69	69	103	103	103
	R	46	46	46	47	47	47
	alpha	20°	20°	20°	15°	15°	15°
Borna para cond. Sección Transvers. (mm ²) min.-máx.	6	6	6	25	25	25	
	-25	-25	-25	-70	-70	-70	

 Grupo de artículos : **1048**

voltages : 400V

rated current : 63A

pole : 4 pole







IP protection types : IP67

position of ground contact : 6h

packing unit : 0005

Peso : 615 g

N° DE REF.

	V	110V	230V	400V	500V	>50-500V
Hz		50,60	50,60	50,60	50,60	100-300 300-500
Color código						 
Amperios						
63 A	3	2179A	2180A	2181A		
	4	203A	204A	205A	206A	
	5	207A	208A	209A	3507	
125 A	3		3575			
	4	210A	211A	212A	213A	
	5	214A	215A	216A		