

DC Cylindrical Housing Type

Upgraded cylindrical photoelectric sensor

■ Features

- External sensitivity adjustment (Diffuse reflective type)
- Waterproof structure by IP66 (IEC standard)
- Detects up to 20m (Transmitted beam type)
- Noise resistant with digital signal processing
- Narrow beam type diffuse reflective sensor using in a narrow space
- Built-in power reverse polarity protection and over current protection circuit
- High environmental resistance BR4M Series with mirror lens



⚠ Please read "Caution for your safety" in operation manual before using.



■ Specifications

Model	NPN open collector	BRP100-DDT	BR100-DDT	BRP400-DDT	BR400-DDT	BRP200-DDTN	BR200-DDTN	BR4M-TDTD	BR4M-TDTL
	PNP open collector	BRP100-DDT-P	BR100-DDT-P	BRP400-DDT-P	BR400-DDT-P	BRP200-DDTN-P	BR200-DDTN-P	BR4M-TDTD-P	BR4M-TDTL-P
Sensing type	Diffuse reflective (Diffusion type)					Diffuse reflective (Narrow beam type)		Transmitted beam	
Sensing distance	100mm (★1)		400mm (★2)		200mm (★2)		4m / 20m		
Sensing target	Transparent, Translucent, Opaque materials							Opaque materials of Min. ϕ 15mm	
Hysteresis	Max. 20% at rated setting distance at rated setting distance							—	
Response time	Max. 1ms							Max. 3ms	
Power supply	12-24VDC \pm 10% (Ripple P-P: Max. 10%)								
Current consumption	Max. 45mA								
Light source	Infrared LED (modulated)								
Sensitivity adjustment	Adjustable VR							Fixed	
Operation mode	Selectable Light ON or Dark ON by control wire							Dark ON	Light ON
Control output	NPN open collector output \Rightarrow Load voltage: Max. 30VDC, Load current: Max. 200mA, Residual voltage: Max. 1VDC PNP open collector output \Rightarrow Output voltage: Min. power voltage - 2.5V, Load current: Max. 200mA								
Protection circuit	Short-circuit protection, Reverse polarity protection								
Indication	Power indicator (Emitter): Red LED, Operation indicator (Receiver): Red LED								
Connection	Outgoing cable								
Insulation resistance	Min. 20M Ω (at 500VDC)								
Noise strength	\pm 240V the square wave noise (pulse width: 1 μ s) by the noise simulator \square								
Dielectric strength	500VAC 50/60Hz for 1 minute								
Vibration	1.5mm amplitude at frequency of 10 ~ 55Hz in each of X, Y, Z directions for 2 hours								
Shock	500m/s ² (50G) in X, Y, Z directions for 3 times								
Ambient illumination	Sunlight : Max. 11,000lx, Incandescent lamp : Max. 3,000lx								
Storage temperature	-10 ~ +60 $^{\circ}$ C (at non-freezing status) Storage : -25 ~ +70 $^{\circ}$ C								
Ambient humidity	35 ~ 85%RH, Storage : 35 ~ 85%RH								
Protection	IP66 (IEC standard)								
Material	<ul style="list-style-type: none"> • BR \Rightarrow Case : C3604BD (Cr-plate), Lens : PC • BRP \Rightarrow Case : Plastic (Black), Lens : PC 							<ul style="list-style-type: none"> • Case \Rightarrow C3604BD (Cr-plate) • Lens \Rightarrow BR4M-Glass BR2M-PC 	
Cable	4P, ϕ 5mm, Length : 2m							Emitter: 2P, ϕ 5mm, Length: 2m Receiver: 3P, ϕ 5mm, Length: 2m	
Accessory	BR : Fixing nuts, Washer / BRP : Fixing nuts								
Approval	CE								
Unit weight \square	• BR series : Approx. 120g			• BRP series : Approx. 100g			Approx. 300g		

※ (★1) (★2) It is for Non-glossy white paper (100 \times 100mm).

(A) Counter

(B) Timer

(C) Temp. controller

(D) Power controller

(E) Panel meter

(F) Tacho/Speed/Pulse meter

(G) Display unit

(H) Sensor controller

(I) Switching power supply

(J) Proximity sensor

(K) Photo electric sensor

(L) Pressure sensor

(M) Rotary encoder

(N) Stepping motor & Driver & Controller

(O) Graphic panel

(P) Production stoppage models & replacement

BR Series

Feature data

Transmitted beam

BR4M-TDT□ / BR4M-TDT□-P

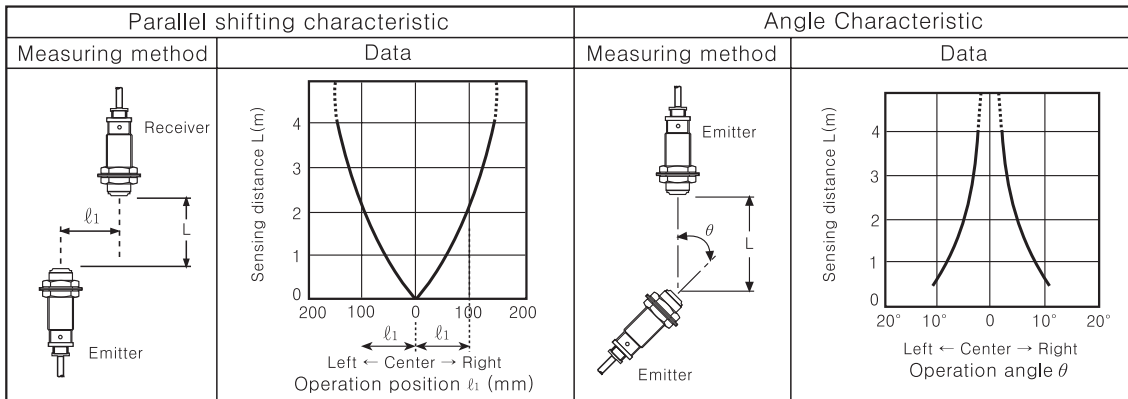

BR20M-TDTD(-P) / BR20M-TDTL(-P)

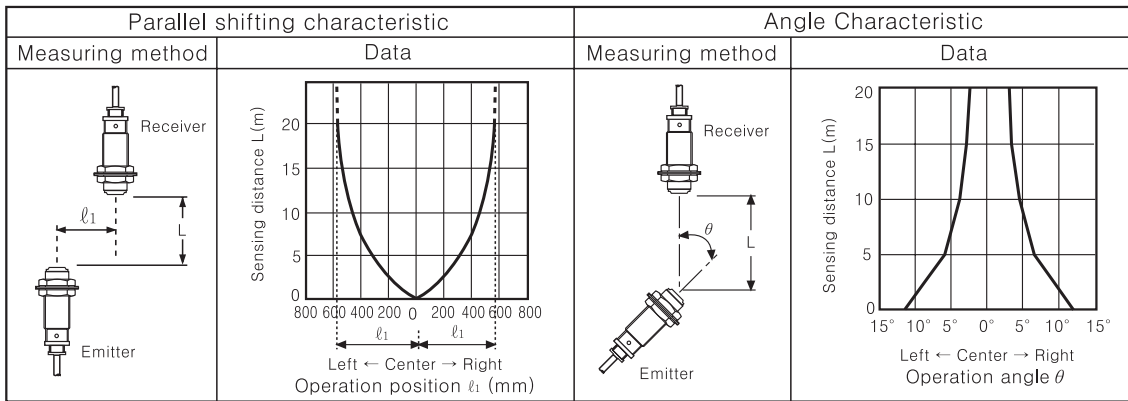

Diffuse reflective

BR100-DDT(-P) / BRP100-DDT(-P)

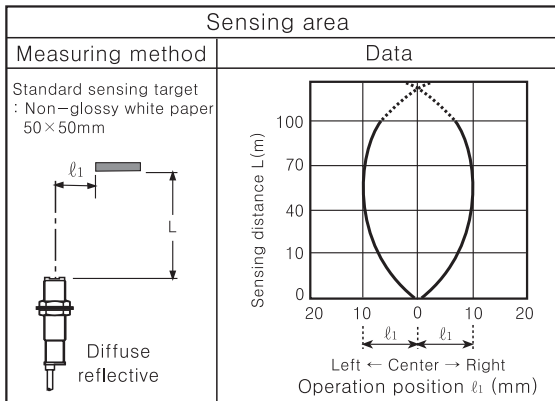

BR200-DDTN(-P) / BRP200-DDTN(-P)

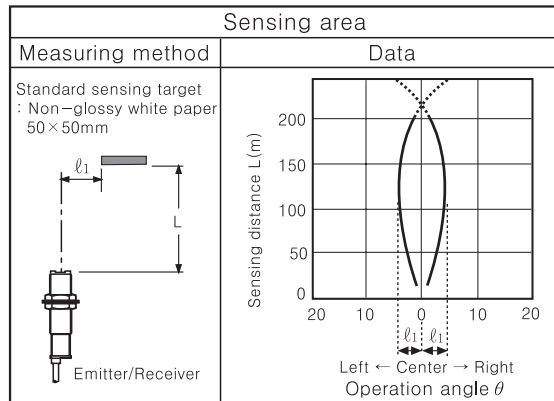

BR400-DDT(-P) / BRP400-DDT(-P)

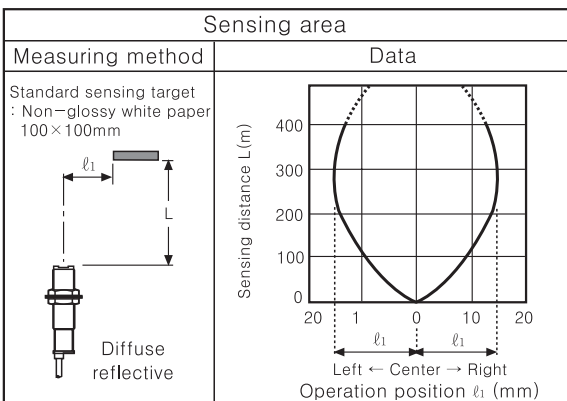

DC Cylindrical Housing Type

Control output diagram

- BR(P)100-DDT / BR(P)200-DDTN / BR(P)400-DDT
- BR20M-TDTD2 / BR20M-TDTL2 (Receiver)

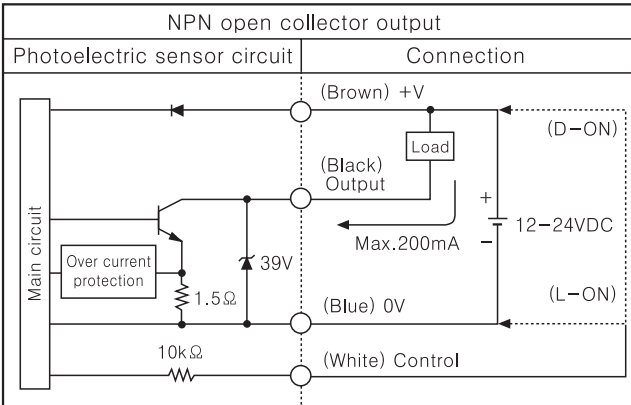

- BR(P)100-DDT-P / BR(P)200-DDTN-P / BR(P)400-DDT-P
- BR20M-TDTD2-P / BR20M-TDTL2-P (Receiver)

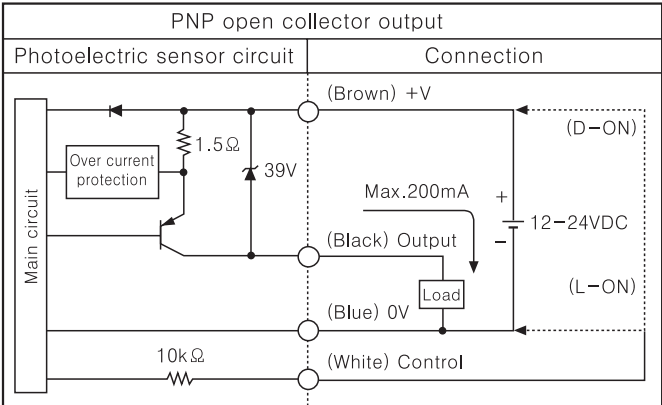

※Select Light ON / Dark ON by control wire. Light ON : Connect control wire to 0V
 Dark ON : Connect control wire to +V
 ※Control wire is available only for diffuse reflective type.

Dimensions

- BR100-DDT(-P) / BR400-DDT(-P)
- BR200-DDTN(-P)

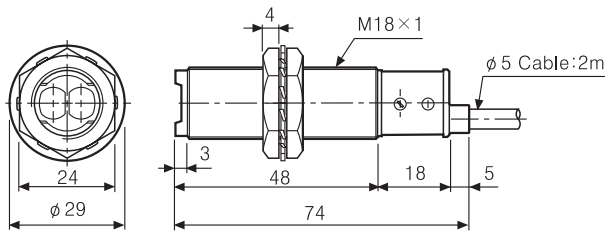

- BRP100-DDT(-P) / BRP400-DDT(-P)
- BRP200-DDTN(-P)

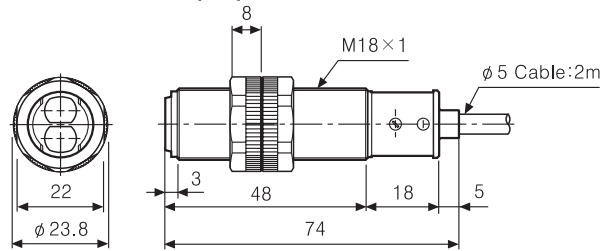

- BR20M-TDTD(L) / BR20M-TDTD(L)-P (Emitter)

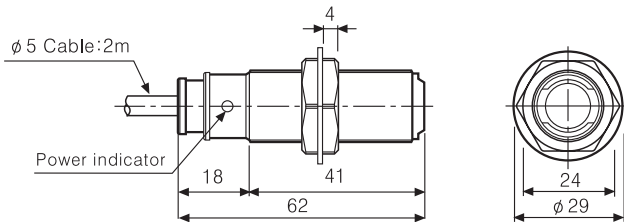

(Receiver)

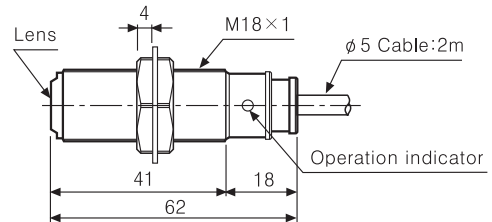

- BR4M-TDTD(L) / BR4M-TDTD(L)-P (Emitter)

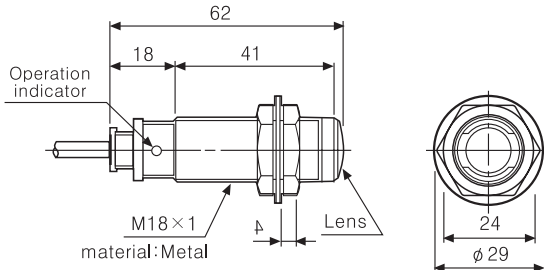

(Receiver)

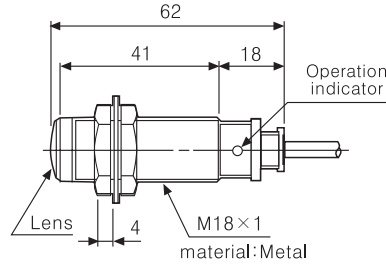

(Unit:mm)

Operation mode

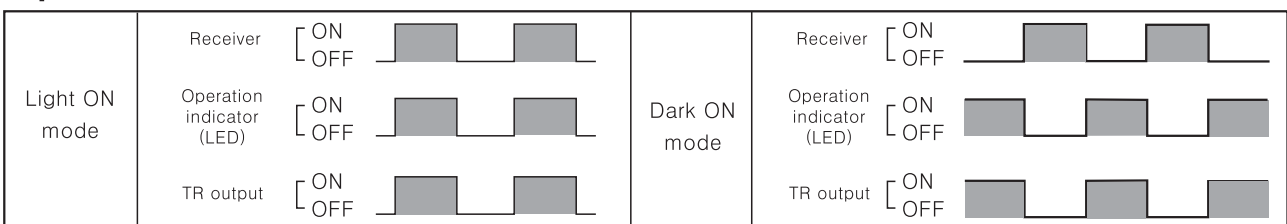

(A) Counter

(B) Timer

(C) Temp. controller

(D) Power controller

(E) Panel meter

(F) Tacho/Speed/Pulse meter

(G) Display unit

(H) Sensor controller

(I) Switching power supply

(J) Proximity sensor

(K) Photo electric sensor

(L) Pressure sensor

(M) Rotary encoder

(N) Stepping motor & Driver & Controller

(O) Graphic panel

(P) Production stoppage models & replacement

BR Series

■ Connections

● Diffuse reflective

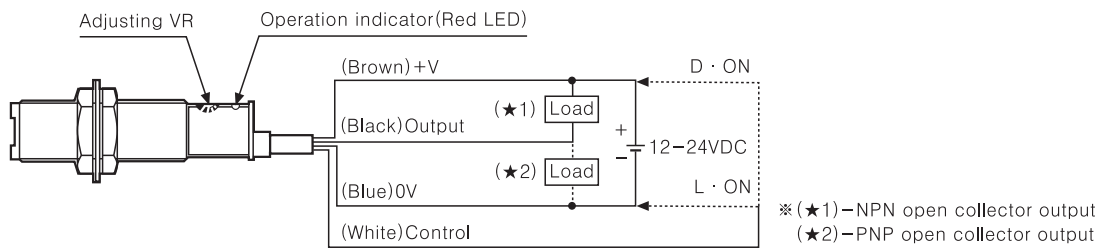

● Transmitted beam

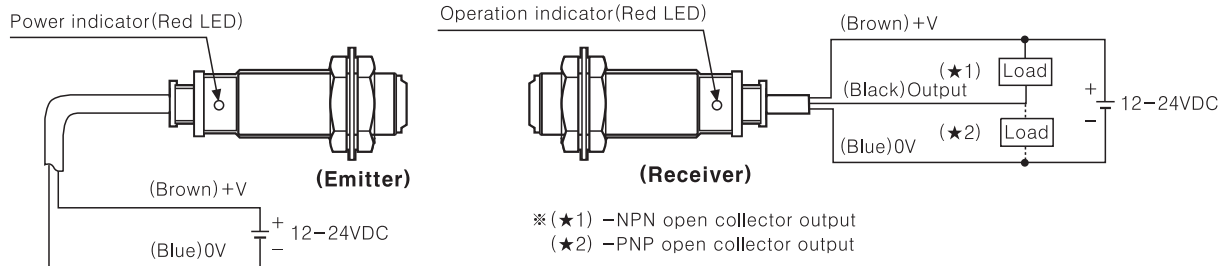

■ Installation and sensitivity adjustment

Please supply the power to the sensor after mount the emitter and the receiver facing each other, and then adjust an optical axis and the sensitivity as follow;

◎ Diffuse Reflective type

1. The sensitivity should be adjusted depending on a sensing target or mounting place.

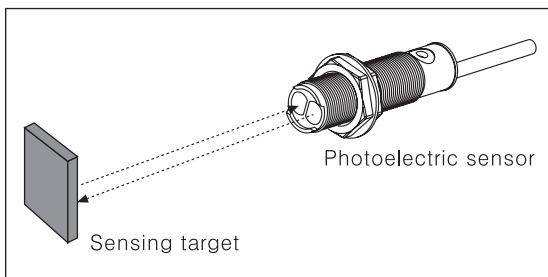

2. Set the target at a position to be detected by the beam, then turn the adjuster until position ① in the middle of the operation range of indicator from Min. position of the adjuster.
3. Take the target out of the sensing area, then turn the adjuster until position ② in the middle of the operation range of indicator. If the indicator does not turn on, max. position is position ②.
4. Set the adjuster in the middle of two switching position ①, ②.

※ The sensing distance indicated in the specification chart is that of non-glossy white paper in the target size 50×50mm. Be sure that it can be different by size, surface and gloss of target.

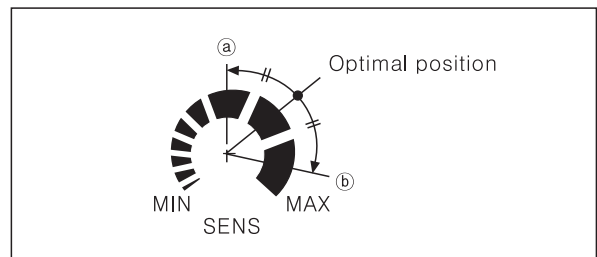

◎ Transmitted Beam type

1. Supply the power to the photoelectric sensor, after mount the emitter and the receiver facing each other.
2. Set the receiver in center of position in the middle of the operation range of indicator adjusting the receiver and the emitter right and left, up and down.
3. Fix both units tightly after checking that the unit detect the target.

