

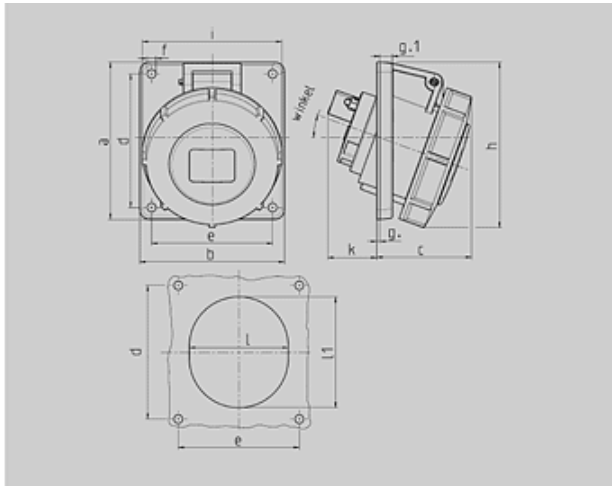

N° de Ref. : 1505

## Base semiempotrable

inclinación 20°



Plano	Amp.	16			32		
		Polos			3	4	5
Dim. en mm	a	73,5	100	100	100	100	100
	b	64	92	92	92	92	92
	c	52	60	62	64	64	66
	d	60	85	85	85	85	85
	e	52	77	77	77	77	77
	f	5,5	5,5	5,5	5,5	5,5	5,5
	g	7	8	8	8	8	8
	h	2	2	2	2	2	2
	i	84	100	105	109	109	113
	k	78	85	96	103	103	110
	l	43	32	32	53	53	45
	l1	52	55	65	67	67	72
	α	60	63	72	82	82	85
	α	20°	20°	20°	20°	20°	20°
Borna para cond.	1,5	1,5	1,5	2,5	2,5	2,5	
Transvers. (mm <sup>2</sup> ) min.-máx.	-4	-4	-4	-10	-10	-10	

 Grupo de artículos : **1048**

voltages : 230V

rated current : 32A

pole : 4 pole







IP protection types : IP67

position of ground contact : 9h

packing unit : 0010

Peso : 280 g

N° DE REF.

V	<b>110V</b>	<b>230V</b>	<b>400V</b>	<b>500V</b>	<b>&gt;50-500V</b>	
Hz	50,60	50,60	50,60	50,60	100-300	300-500
Color código						
Amperios						
<b>16 A</b>	3	1474	1475	1476		
	4		1478	1479	1480	1481
	5			1485		
<b>32 A</b>	3	1501	1502	1503		
	4		<u>1505</u>	1506	1507	1567
	5			1551		