

panel mounting socket outlet angled - flange 85x85, fixing centers 70x70

Product description

Order number	12080
EAN/pcs	4024941120807
Product Group	GT panel mounting socket outlet, angled
Amperage	16A
Poles	3p (2P+PE)
Earth 'Clock' Position	6 h
Voltage	200 up to 250V
Frequency	50 and 60Hz
Protection	IP44
Color code	blue RAL 5015
Connection Design	screw terminal
Max. conductor	4,0 mm ²



Further Information

Additional technical information The inclination is 20°

Material

Material of Enclosure	Polyamide
Contact / Contact Carrier	contact carrier made of polyamide, the contacts are brass
Weight/pcs	0.123 kg
Packaging unit	10 pcs

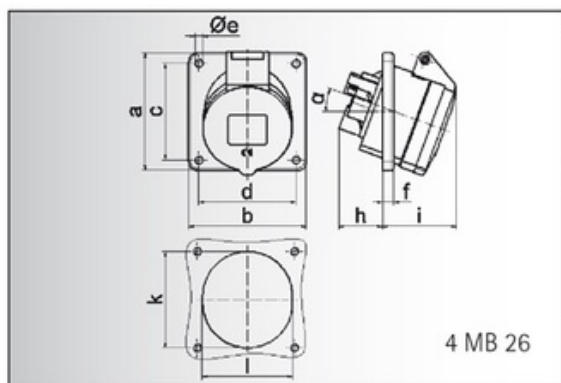

Ampere	16	16	16	32	32	32
Polzahl	3	4	5	3	4	5
a	85,0	85,0	85,0	85,0	85,0	85,0
b	85,0	85,0	85,0	85,0	85,0	85,0
c	70,0	70,0	70,0	70,0	70,0	70,0
d	70,0	70,0	70,0	70,0	70,0	70,0
e Ø	5,5	5,5	5,5	5,5	5,5	5,5
f	8,0	8,0	8,0	8,0	8,0	8,0
h	30,0	30,0	30,0	50,0	50,0	34,0
i	48,0	50,0	54,0	63,0	63,0	60,0
k	57,0	65,0	70,0	78,0	78,0	78,0
l	57,0	65,0	70,0	78,0	78,0	78,0
α	20°	20°	20°	20°	20°	20°
Leiter mm ² min	1,5	1,5	1,5	2,5	2,5	2,5
Leiter mm ² max	4	4	4	10	10	10