

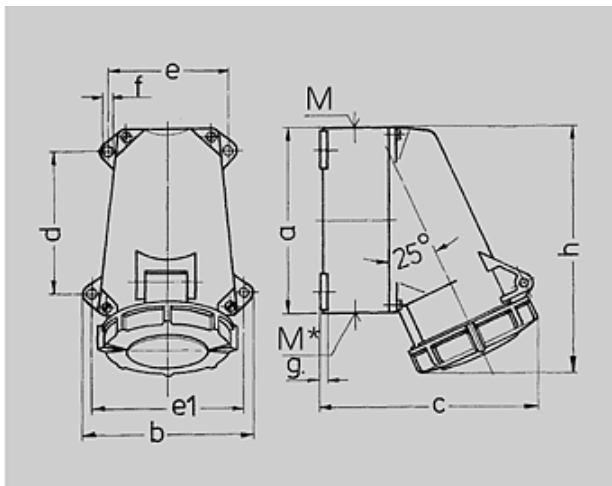

N° de Ref. : 1196

**Base**

con cuatro fijaciones exteriores, una entrada de cable superior y una ciega (para cortar) inferior



Plano	Amp.	16			32		
		Polos			3	4	5
1 MB 219							
Dim. en mm	a	95	95	95	120	120	120
	b	102	102	102	112	112	112
	c	115	124	129	143	143	150
	d	64,2	64,2	64,2	90,2	90,2	90,2
	e	77,5	77,5	77,5	79	79	79
	e1	88	88	88	98,5	98,5	98,5
	f	5,5	5,5	5,5	5,5	5,5	5,5
	g	5	5	5	5	5	5
	h	128	128	132	160	160	160
	M	20	25	25	32	32	32
	M*	20	25	25	M 32 (ciega)		
		(ciega) para cortar			para cortar		
Diám. máx. de cable (mm)		15	18	18	25	25	25
Borna para cond. Sección Transvers. (mm <sup>2</sup> ) min.-máx.		1,5	1,5	1,5	2,5	2,5	2,5
		-4	-4	-4	-10	-10	-10

 Grupo de artículos : **1049**

voltages : 400V

rated current : 16A

pole : 4 pole







IP protection types : IP67

position of ground contact : 6h

packing unit : 0010

Peso : 270 g

## N° DE REF.

V	110V	230V	400V	500V	>50-500V	
Hz	50,60	50,60	50,60	50,60	100-300	300-500
Color código						
Amperios						
<b>16 A</b>	3	1193	1192	1211		
	4	1194	1195	<b>1196</b>	1197	1212
	5	1198	1199	1200		
<b>32 A</b>	3	1201	1202	1203		
	4	1204	1205	1206	1207	1214
	5	1208	1209	1210		