



SIRIUS SOFT STARTER, S6, 162 A,
90 KW/400 V, 40 DEG., 200-460 V AC,
230 V AC, SCREW TERMINALS

General details:

product brand name		SIRIUS
Product equipment		
• integrated bridging contact system		Yes
• thyristors		Yes
Product function		
• intrinsic device protection		Yes
• motor overload protection		Yes
• evaluation of thermal resistor motor protection		No
• reset external		Yes
• adjustable current limitation		Yes
• inside-delta circuit		No
Product component / outlet for enine brake		No
Reference code		
• according to DIN EN 61346-2		Q
• according to DIN 40719 extended according to IEC 204-2 / according to IEC 750		G

Power Electronics:

Product designation		soft starters for standard applications
Operating current		

• at 40 °C / rated value	A	162
• at 50 °C / rated value	A	145
• at 60 °C / rated value	A	125
Emitted mechanical power / for three-phase servomotors		
• at 230 V / at standard switching / at 40 °C		
• rated value	W	45,000
• at 400 V / at standard switching / at 40 °C		
• rated value	W	90,000
yielded mechanical performance [hp] / for three-phase squirrel cage motors / at 200/208 V / at standard circuit / at 50 °C / rated value	hp	40
Operating frequency		
• rated value	Hz	50 ... 60
Relative negative tolerance / of the operating frequency	%	-10
Relative positive tolerance / of the operating frequency	%	10
Operating voltage / with standard circuit / rated value	V	200 ... 460
Relative negative tolerance / of the operating voltage / with standard circuit	%	-15
Relative positive tolerance / of the operating voltage / with standard circuit	%	10
Minimum load in % of I_M	%	20
Adjustable rated current of the motor / for motor overload protection / minimum	A	87
Continuous operating current in % of I_e / at 40°C	%	115
Active power loss / at operating current / at 40°C / during operating phase / typical	W	75

Control electronics:

Voltage type / of control feed voltage		AC
Control supply voltage frequency / 1 / rated value	Hz	50
Control supply voltage frequency / 2 / rated value	Hz	60
Relative negative tolerance / of the control supply voltage frequency	%	-10
Relative positive tolerance / of the control supply voltage frequency	%	10
Control supply voltage / 1		
• for AC / at 50 Hz	V	230
• for AC / at 60 Hz	V	230
Relative negative tolerance / of the control supply voltage / at 60 Hz / for AC	%	-15
Relative positive tolerance / of the control supply voltage / at 60 Hz / for AC	%	10
Type of display / for fault signal		red

Mechanical design:		
Size of the engine control device		S6
Width	mm	120
Height	mm	198
Depth	mm	250
Mounting type		screw fixing
mounting position		With additional fan: With vertical mounting surface +/- 90° rotatable, with vertical mounting surface +/- 22.5° tiltable to the front and back Without additional fan: With vertical mounting surface +/- 10° rotatable, with vertical mounting surface +/- 10° t
Distance, to be maintained, to the ranks assembly		
• upwards	mm	100
• sideways	mm	5
• downwards	mm	75
Installation altitude / at a height over sea level	m	5,000
Cable length / maximum	m	300
Number of poles / for main current circuit		3









Electrical connections:		
Design of the electrical connection		
• for main current circuit		busbar connection
• for auxiliary and control current circuit		screw-type terminals
Number of NC contacts / for auxiliary contacts		0
Number of NO contacts / for auxiliary contacts		2
Number of changeover contacts / for auxiliary contacts		1
Type of the connectable conductor cross-section / for main contacts / for box terminal / when using the front clamping point		
• finely stranded / with conductor end processing		16 ... 70 mm ²
• finely stranded / without conductor end processing		16 ... 70 mm ²
• stranded		16 ... 70 mm ²
Type of the connectable conductor cross-section / for main contacts / for box terminal / when using the back clamping point		
• finely stranded / with conductor end processing		16 ... 70 mm ²
• without conductor final cutting / without conductor end processing		16 ... 70 mm ²
• stranded		16 ... 70 mm ²
Type of the connectable conductor cross-section / for main contacts / for box terminal / when using both clamping points		
• finely stranded / with conductor end processing		max. 1x 50 mm ² , 1x 70 mm ²
• without conductor final cutting / without conductor end processing		max. 1x 50 mm ² , 1x 70 mm ²

<ul style="list-style-type: none"> stranded 		max. 2x 70 mm ²
Type of the connectable conductor cross-section / for AWG conductors / for main contacts / for box terminal <ul style="list-style-type: none"> when using the back cl when using the front c when using both clampi 		6 ... 2/0 6 ... 2/0 max. 2x 1/0
Type of the connectable conductor cross-section / for DIN cable lug / for main contacts <ul style="list-style-type: none"> finely stranded stranded 		16 ... 95 mm ² 25 ... 120 mm ²
Type of the connectable conductor cross-section <ul style="list-style-type: none"> for AWG conductors / for main contacts 		4 ... 250 kcmil
Type of the connectable conductor cross-section <ul style="list-style-type: none"> for auxiliary contacts <ul style="list-style-type: none"> solid finely stranded / with conductor end processing for AWG conductors / for auxiliary contacts <ul style="list-style-type: none"> finely stranded / with wire end proc 		2x (0.5 ... 2.5 mm ²) 2x (0.5 ... 1.5 mm ²) 2x (20 ... 14) 2x (20 ... 16)

Ambient conditions:

Ambient temperature <ul style="list-style-type: none"> during operating during storage 	°C	-25 ... +60
	°C	-40 ... +80
Derating temperature	°C	40
Protection class IP		IP00

Certificates/approvals:

General Product Approval	EMC	For use in hazardous locations	Test Certificates
 CSA  EAC  UL	 C-TICK	 ATEX	Special Test Certificate
Shipping Approval	other		
 DNV  GL  LRS	Declaration of Conformity Environmental Confirmations		

UL/CSA ratings

yielded mechanical performance [hp] / for three-phase squirrel cage motors <ul style="list-style-type: none"> at 220/230 V / at standard circuit at 50 °C / rated value 	hp	50
--	----	----

- at 460/480 V / at standard circuit
- at 50 °C / rated value

hp

100

Contact rating designation / for auxiliary contacts / according to UL

B300 / R300

Further information:

Information- and Downloadcenter (Catalogs, Brochures,...)

<http://www.siemens.com/industrial-controls/catalogs>

Industry Mall (Online ordering system)

<http://www.siemens.com/industrial-controls/mall>

CAX-Online-Generator

<http://www.siemens.com/cax>

Service&Support (Manuals, Certificates, Characteristics, FAQs,...)

<http://support.automation.siemens.com/WW/view/en/3RW4056-6BB44/all>

Image database (product images, 2D dimension drawings, 3D models, device circuit diagrams, ...)

http://www.automation.siemens.com/bilddb/cax_en.aspx?mlfb=3RW4056-6BB44

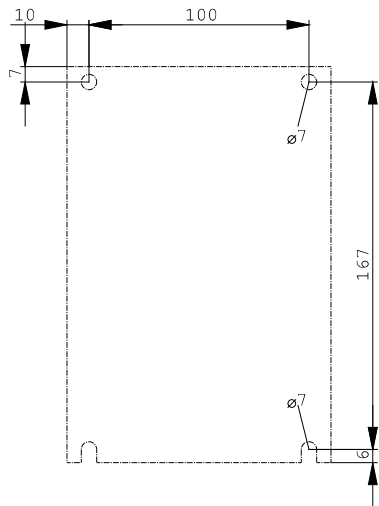
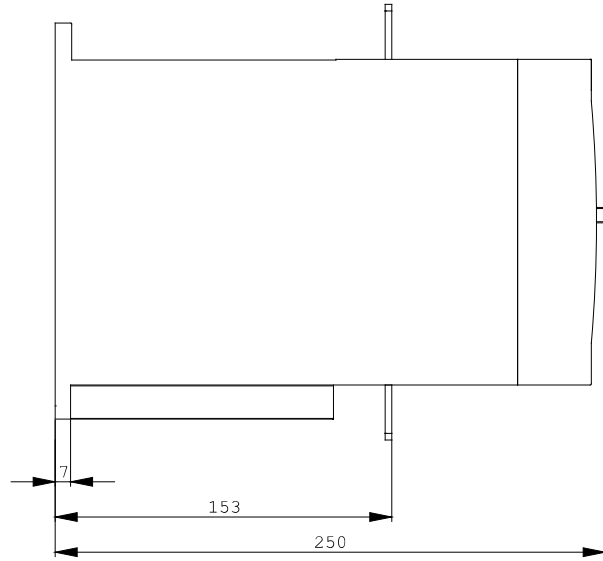
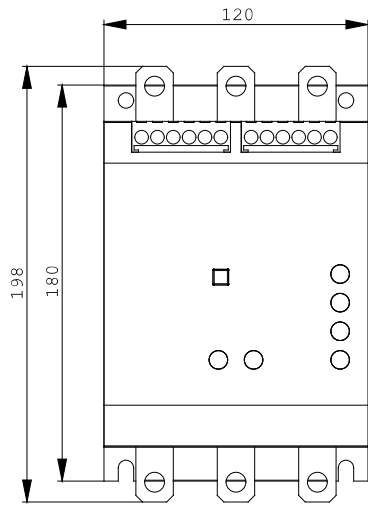

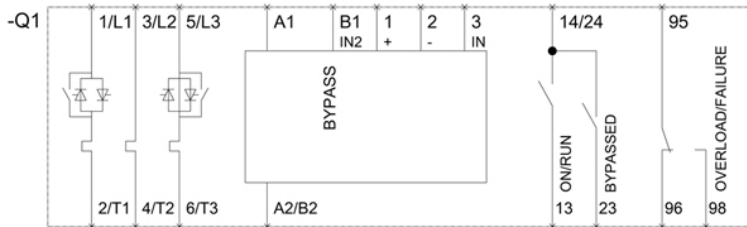

last change:

Jul 7, 2014