

panel mounting socket outlet angled - flange 85x85, fixing centers 70x70

Product description

Order number	12813
EAN/pcs	4024941128131
Product Group	Panel mounting socket outlet Quick-Connect, angled
Amperage	16A
Poles	3p (2P+PE)
Earth 'Clock' Position	6 h
Voltage	200 up to 250V
Frequency	50 and 60Hz
Protection	IP67
Color code	blue RAL 5015
Connection Design	screwless spring terminals as cage clamp with Kontext-contact
Max. conductor	4,0 mm ²



Further Information

Additional technical information The inclination is 20°

Material

Material of Enclosure	Polyamide
Contact / Contact Carrier	contact carrier made of polyamide, the contacts are brass
Weight/pcs	0.148 kg
Packaging unit	10 pcs

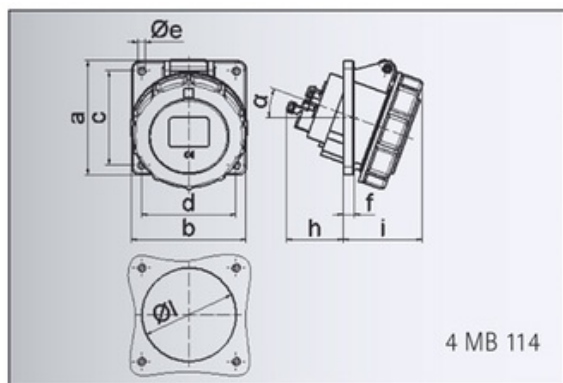

Ampere	16	16	16	32	32	32
Polzahl	3	4	5	3	4	5
a	85,0	85,0	85,0	85,0	85,0	85,0
b	85,0	85,0	85,0	85,0	85,0	85,0
c	70,0	70,0	70,0	70,0	70,0	70,0
d	70,0	70,0	70,0	70,0	70,0	70,0
e Ø	5,5	5,5	5,5	5,5	5,5	5,5
f	8,0	8,0	8,0	8,0	8,0	8,0
h	46,0	46,0	46,0	61,0	61,0	61,0
i	57,0	57,0	60,0	65,0	65,0	69,0
l Ø	57,0	65,0	70,0	78,0	78,0	78,0
α	20°	20°	20°	20°	20°	20°
Leiter mm ² min	1,5	1,5	1,5	2,5	2,5	2,5
Leiter mm ² max	4	4	4	10	10	10