

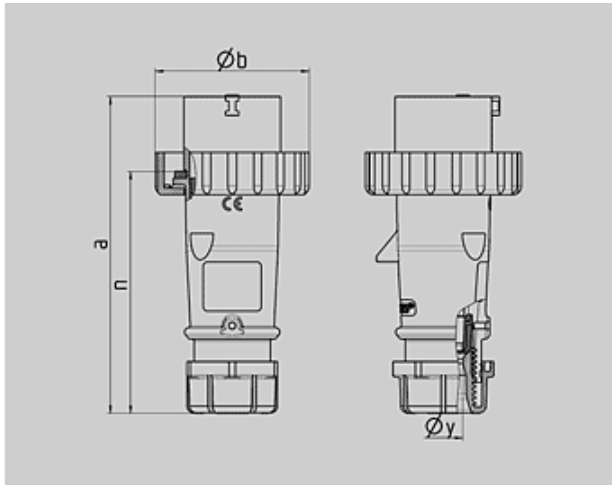

N° de Ref. : 283

**Clavija AM-TOP**

carcasa de una pieza, prensaestopas roscado con estanqueidad, antitracción y protección contra doblado del cable



| Plano  | Amp. | 16             |      |      | 32  |     |     |
|--|------|----------------|------|------|-----|-----|-----|
|  |      | 2 MB 218 Polos |      |      | 3   | 4   | 5   |
| Dim. en mm   | a    | 142            | 144  | 147  | 186 | 186 | 180 |
|  | b    | 70             | 78   | 87   | 94  | 94  | 101 |
|  | n    | 109            | 111  | 114  | 145 | 145 | 138 |
|  | y    | 14,5           | 16   | 16   | 22  | 22  | 22  |
| Borna para cond. Sección Transvers. (mm <sup>2</sup> ) min.-máx. |      | 1              | 1    | 1    | 2,5 | 2,5 | 2,5 |
|  |      | -2,5           | -2,5 | -2,5 | -6  | -6  | -6  |

 Grupo de artículos : **2149**

voltages : 500V

rated current : 16A

pole : 4 pole







IP protection types : IP67

position of ground contact : 7h

packing unit : 0010

Peso : 165 g

**N° DE REF.**

| V            | <b>110V</b>   | <b>230V</b>   | <b>400V</b>   | <b>500V</b>   | <b>&gt;50-500V</b>  |   |
|--------------|---|---|---|---|---|---|
| Hz           | 50,60   | 50,60   | 50,60   | 50,60   | 100-300   | 300-500   |
| Color código |  |  |  |  |  |  |
| Amperios     |   |   |   |   |   |   |
| <b>16 A</b>  | 3   | 277   | 278   | 279   |   |   |
|              | 4   | 280   | 281   | 282   | <u>283</u>  | 284   |
|              | 5   | 286   | 287   | 288   |   |   |
| <b>32 A</b>  | 3   | 289   | 290   | 291   |   |   |
|              | 4   | 292   | 293   | 294   | 295   | 296   |
|              | 5   | 298   | 299   | 300   |   |   |