

N° de Ref. : 300

**Clavija AM-TOP**

carcasa de una pieza, prensaestopas roscado con estanqueidad, antitracción y protección contra doblado del cable

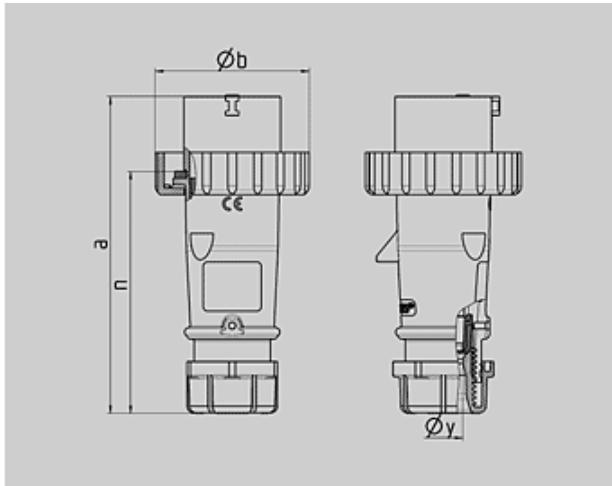

Plano	Amp.	16			32		
		2 MB 218 Polos			3	4	5
Dim. en mm	a	142	144	147	186	186	180
	b	70	78	87	94	94	101
	n	109	111	114	145	145	138
	y	14,5	16	16	22	22	22
Borna para cond. Transvers. (mm²) min.-máx.		1	1	1	2,5	2,5	2,5
		-2,5	-2,5	-2,5	-6	-6	-6

 Grupo de artículos : **2149**

voltages : 400V

rated current : 32A

pole : 5 pole







IP protection types : IP67

position of ground contact : 6h

packing unit : 0010

Peso : 300 g

N° DE REF.

V	<b>110V</b>	<b>230V</b>	<b>400V</b>	<b>500V</b>	<b>&gt;50-500V</b>	
Hz	50,60	50,60	50,60	50,60	100-300	300-500
Color código						
Amperios						
<b>16 A</b>	3	277	278	279		
	4	280	281	282	283	284
	5	286	287	288		
<b>32 A</b>	3	289	290	291		
	4	292	293	294	295	296
	5	298	299	<b>300</b>		