

N° de Ref. : 278

Clavija AM-TOP

carcasa de una pieza, prensaestopas roscado con estanqueidad, antitracción y protección contra doblado del cable

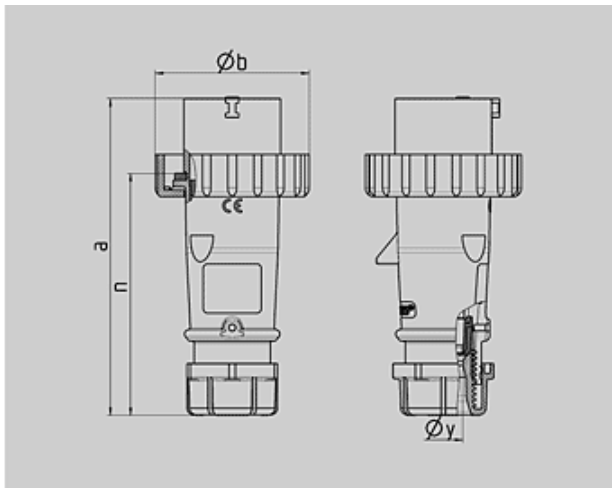

Plano	Amp.	16			32		
		2 MB 218 Polos			3	4	5
Dim. en mm	a	142	144	147	186	186	180
	b	70	78	87	94	94	101
	n	109	111	114	145	145	138
	y	14,5	16	16	22	22	22
Borna para cond. Transvers. (mm²) min.-máx.		1	1	1	2,5	2,5	2,5
		-2,5	-2,5	-2,5	-6	-6	-6

 Grupo de artículos : **2149**

voltages : 230V

rated current : 16A

pole : 3 pole







IP protection types : IP67

position of ground contact : 6h

packing unit : 0010

Peso : 133 g

N° DE REF.

V	110V	230V	400V	500V	>50-500V	
Hz	50,60	50,60	50,60	50,60	100-300	300-500
Color código						
Amperios						
16 A	3	277	278	279		
	4	280	281	282	283	284
	5	286	287	288		
32 A	3	289	290	291		
	4	292	293	294	295	296
	5	298	299	300		